

NEC

1. Introduction

2. Hotel/Motel Features

3. Programming
Procedures

4. Setting Up Flexible
System Numbering

The logo for Aspire, featuring the word "Aspire" in a blue, italicized, sans-serif font.

Hotel/Motel Manual

Technical Support Web Site:
<http://ws1.necii.com> (registration is required)

This manual has been developed by NEC Unified Solutions, Inc. It is intended for the use of its customers and service personnel, and should be read in its entirety before attempting to install or program the system. Any comments or suggestions for improving this manual would be appreciated. Forward your remarks to:

NEC Unified Solutions, Inc.
4 Forest Parkway
Shelton, CT 06484
www.necunifiedsolutions.com

Nothing contained in this manual shall be deemed to be, and this manual does not constitute, a warranty of, or representation with respect to, any of the equipment covered. This manual is subject to change without notice and NEC Unified Solutions, Inc. has no obligation to provide any updates or corrections to this manual. Further, NEC Unified Solutions, Inc. also reserves the right, without prior notice, to make changes in equipment design or components as it deems appropriate. No representation is made that this manual is complete or accurate in all respects and NEC Unified Solutions, Inc. shall not be liable for any errors or omissions. In no event shall NEC Unified Solutions, Inc. be liable for any incidental or consequential damages in connection with the use of this manual. This document contains proprietary information that is protected by copyright. All rights are reserved. No part of this document may be photocopied or reproduced without prior written consent of NEC Unified Solutions, Inc.

©2006 by NEC Unified Solutions, Inc. All Rights Reserved.
Printed in U.S.A.

Section 1:**Introduction 1-1****Introduction 1-1**

Wake Up Call	1-1
Single Digit Dialing	1-2
Message Waiting	1-2
Room-to-Room Calling Restriction	1-2
Toll Restriction (When Checked In)	1-2
Room Status	1-2
Room Status Printouts	1-2
DSS Console Monitoring	1-3
Do Not Disturb	1-3
Flexible Numbering Plan	1-3
Hotel/Motel Feature Quick Reference	1-4

Section 2**Hotel/Motel Features 2-1**

Do Not Disturb	2-2
Using Do Not Disturb	2-2
Setting Up Do Not Disturb	2-3
Programming	2-3
DSS Console Monitoring	2-4
Using DSS Console Monitoring	2-4
Setting Up DSS Console Monitoring	2-6
Programming	2-6
Message Waiting	2-7
Using Message Waiting	2-7
Setting Up Message Waiting	2-8
Programming	2-8
Room Status	2-9
Using Room Status	2-10
Setting Up Room Status	2-11
Programming	2-12
Room Status Printouts	2-13
Using Room Status Printouts	2-14
Setting Up Room Status Printouts	2-15
Programming	2-16
Room-to-Room Call Restriction	2-17
Using Room-to-Room Call Restriction	2-17
Setting Up Room-to-Room Call Restriction	2-18
Programming	2-18

Single Digit Dialing	2-19
Using Single Digit Dialing	2-19
Setting Up Single Digit Dialing	2-20
Programming	2-20
Toll Restriction (When Checked In)	2-21
Using Toll Restriction (When Checked In)	2-22
Setting Up Toll Restriction (When Checked In)	2-22
Programming	2-23
Wake Up Call	2-24
Using Wake Up Call	2-25
Setting Up Wake Up Call	2-26
Programming	2-27

Section 3

Programming Procedures. 3-1

Before You Start Programming	3-3
How to Use This Section	3-3
How to Enter the Programming Mode	3-4
How to Exit the Programming Mode	3-5
Using Keys to Move Around in the Programs	3-6
Programming Names and Text Messages	3-7
Using Soft Keys For Programming	3-8
What the Soft Key Display Prompts Mean	3-9
11-14 : Service Code Setup (for Hotel)	3-11
Description	3-11
Feature Cross Reference	3-12
Telephone Programming Instructions	3-12
15-03 : Single Line Telephone Basic Data Setup	3-13
Description	3-13
Feature Cross Reference	3-13
Telephone Programming Instructions	3-14
20-06 : Class of Service for Extensions	3-15
Description	3-15
Feature Cross Reference	3-15
Telephone Programming Instructions	3-16
20-13 : Class of Service Options (Supplementary)	3-17
Description	3-17
Feature Cross Reference	3-17
Telephone Programming Instructions	3-18
20-17 : Operator's Extension	3-19
Description	3-19
Feature Cross Reference	3-19
Telephone Programming Instructions	3-20

21-04 : Toll Restriction Class for Extensions	3-21
Description	3-21
Feature Cross Reference	3-21
Telephone Programming Instructions	3-22
21-05 : Toll Restriction Class	3-23
Description	3-23
Feature Cross Reference	3-25
Telephone Programming Instructions	3-25
21-06 : Toll Restriction Table Data Setup	3-26
Description	3-26
Feature Cross Reference	3-27
Telephone Programming Instructions	3-28
30-01 : DSS Console Operating Mode	3-29
Description	3-29
Feature Cross Reference	3-29
Telephone Programming Instructions	3-30
30-02 : DSS Console Extension Assignment	3-31
Description	3-31
Feature Cross Reference	3-31
Telephone Programming Instructions	3-32
42-01 : System Options for Hotel/Motel	3-33
Description	3-33
Feature Cross Reference	3-33
Telephone Programming Instructions	3-34
42-02 : Hotel/Motel Telephone Setup	3-35
Description	3-35
Feature Cross Reference	3-35
Telephone Programming Instructions	3-36
42-03 : Class of Service Options (Hotel/Motel)	3-37
Description	3-37
Feature Cross Reference	3-38
Telephone Programming Instructions	3-39
42-04 : Hotel Mode One-Digit Service Codes	3-40
Description	3-40
Feature Cross Reference	3-40
Telephone Programming Instructions	3-41
42-05 : Hotel Room Status Printer	3-42
Description	3-42
Feature Cross Reference	3-42
Telephone Programming Instructions	3-43

90-11 : System Alarm Report 3-44
Description 3-44
Feature Cross Reference 3-45
Telephone Programming Instructions 3-45

Section 4

Setting Up Flexible

System Numbering 4-1

When to Use Flexible System Numbering 4-3
System Number Plan/Capacities 4-4

An Example 4-11
Setting Up Flexible System Numbering 4-11

Programming Flow Chart 4-12

Programming 4-13

11-01 : System Numbering 4-13
Description 4-13
Feature Cross Reference 4-22
Telephone Programming Instructions 4-22

11-02 : Extension Numbering 4-23
Description 4-23
Feature Cross Reference 4-24
Telephone Programming Instructions 4-24

11-09 : Trunk Access Code 4-25
Description 4-25
Feature Cross Reference 4-26
Telephone Programming Instructions 4-26

11-10 : Service Code Setup (System Administrator) 4-27
Description 4-27
Feature Cross Reference 4-29
Telephone Programming Instructions 4-29

11-11 : Service Code Setup (Setup/Entry Operation) 4-30
Description 4-30
Feature Cross Reference 4-32
Telephone Programming Instructions 4-33

11-12 : Service Code Setup (for Service Access) 4-34
Description 4-34
Feature Cross Reference 4-37
Telephone Programming Instructions 4-37

11-13 : Service Code Setup (for ACD) 4-38
Description 4-38
Feature Cross Reference 4-39
Telephone Programming Instructions 4-39

11-14 : Service Code Setup (for Hotel)	4-40
Description	4-40
Feature Cross Reference	4-41
Telephone Programming Instructions	4-41
11-15 : Service Code Setup, Administrative	4-42
Description	4-42
Feature Cross Reference	4-43
Telephone Programming Instructions	4-43
11-16 : Single Digit Service Code Setup	4-44
Description	4-44
Feature Cross Reference	4-45
Telephone Programming Instructions	4-45
15-01 : Basic Extension Data Setup	4-46
Description	4-46
Feature Cross Reference	4-47
Telephone Programming Instructions	4-48

Section 1:

Introduction

1

Introduction

Comprehensive Hotel/Motel Features . . .

Providing service and convenience for your guests . . .

With economy and efficiency for you . . .

Your Aspire telephone system, with system software 5.00 or higher, provides comprehensive Hotel/Motel services in addition to the many features available to business users. These Hotel/Motel services help you run your facility more efficiently, save you time and money *and* provide your guests with more responsive service. Hotel/Motel feature include:

Wake Up Call

Wake Up Call is like having an alarm clock in each room — with some unique advantages:

- Guests can set or cancel Wake Up Calls for themselves, or you can set and cancel Wake Ups for them.
- You can view the status of all your system's Wake Up Calls from your DSS Console.
- Unanswered Wake Up Calls can automatically call the operator and print on the Room Status Printout report.
- Use Wake Up Call as a meeting reminder (e.g., for convention attendees).

Single Digit Dialing

Single Digit Dialing gives your guests one-touch access to your important Hotel/Motel services. They can just lift the handset and press a single key for:

- Extensions such as the front desk, reservation services, housekeeping or the maitre d' of your restaurant.
- Feature Access Codes for one button access to selected features and outside lines.
- Voice Mail, so your guests can leave requests even when your service providers are unavailable.
- A Department Calling Group allowing, for example, your guests to reach the first available agent in your reservation desk group.

Message Waiting

If you call a guest while they are away from their room, leave them a Message Waiting. When the guest returns, they will see the lamp on their phone flashing and can automatically call you back. You can use Message Waiting when you have parcels for a guest dropped off at your front desk. Don't keep redialing the guest if they are not in — just send them a Message Waiting. (Your DSS Console can show all the rooms that have messages waiting.)

Room-to-Room Calling Restriction

Prevent guests in one room from calling guests in another — a handy feature for guests that want to maintain their privacy. If you need to, you can always allow inter-room calling (e.g., for families or groups that have separate rooms).

Toll Restriction (When Checked In)

Control your guest's long distance dialing automatically when they check in. Use this feature to set up two different Toll Restriction modes. The first mode is for you and your staff when the room is checked out. The second mode is for your guests when they check in. You may want to restrict the outside numbers guests can dial, but allow your staff to call vendors and suppliers.

Room Status

Your phone and DSS Console can set and monitor the status of all your guest rooms: *Checked In*, *Checked Out*, *Maid Required* and *Maid in Room*. Maximize room usage by coordinating your cleaning staff and reservation desk. For example, you can dial simple codes to set a room's status. And, just press STATUS on your console to see the status of all your rooms at a single glance.

Room Status Printouts

The Room Status Printouts give you a concise overview of the status of all your guest rooms at a glance. The printouts provide up to the minute reports showing Room Status, Room Call Restriction, Do Not Disturb, Message Waiting and Wake Up Calls. If your cleaning staff needs to know which rooms to clean up, for example, just print out the report showing Room Status. Room-to-Room

DSS Console Monitoring

Your DSS Console provides unique one-touch room monitoring capabilities. Just press a button on your DSS Console to check a room's status. Or, see at a glance which rooms have Wake Up Calls set or messages waiting. In addition, you can still use your console for business mode features.

Do Not Disturb

A guest can activate DND any time they need privacy (for example, if they need to work uninterrupted). Do Not Disturb (DND) blocks the room telephone's incoming calls and Paging announcements.

Flexible Numbering Plan

To simplify dialing guests and services in your facility, customize your system to have room numbers match each phone's extension number. For example, if the rooms on the first floor are numbered 100-120, the corresponding room extensions can also be 100-120.

- For Your Notes -

1

Hotel/Motel Feature Quick Reference Chart

Do Not Disturb

Enable DND at a room phone:	Lift handset + 127 + Hang up.
Cancel DND at a room phone:	Lift handset + 128 + Hang up.
Enable DND for another room phone:	Lift handset + 129 + Extension for which you want to enable DND + Hang up.
Cancel DND enabled at another room phone:	Lift handset + 130 + Extension for which you want to disable DND + Hang up.

DSS Console Monitoring

Check which room phones have Messages Waiting:	Without lifting the handset, press MESSAGE (PAGE).
Check which room phones have Wake Up Calls set:	Without lifting the handset, press WAKE UP (GROUP).
View the Check Out Status of a room:	Without lifting the handset, press STATUS (DOOR).

Message Waiting

Leave a Message Waiting:	Call the room telephone + 0 + Hang up.
Cancel a Message Waiting:	Lift handset + 873 . OR You know the extension at which you left the message: Lift handset + 871 + Extension .
Leave a Message Waiting without first calling the extension:	Lift handset + 126 + Extension .
Answer a Message Waiting left at your phone:	Lift handset + *0 .

Room Status

Check-in Options

Set a room as checked in:	Lift handset + 138 + Extension of the room you want to check in + Hang up.
Set a room as checked out:	If you have previously dialed 138 to check it in, lift handset + 139 + Extension of the room you want to check out + Hang up.

House Cleaning Options

Set a room's house cleaning status from the room phone:	Lift handset + 140 + Room status code (1-4) + Hang up. <i>(1 = Room Clean (Occupied), 2 = Maid Required, 3 = Maid in Room, 4 = Inspection Required)</i>
Set a room's status from another phone:	Lift handset + 141 + Extension of the room you want to set + Room status code (1-4) + Hang up. <i>(1 = Room Clean (Occupied), 2 = Maid Required, 3 = Maid in Room, 4 = Inspection Required)</i>

Room Status Printouts

Have your printer output the Room Status Printout:	Lift handset + 142 + Room Status Printout option (0-5) + Hang up. <i>(0 = All Printouts, 1 = Room Status List (Check-in and House Cleaning Status), 2 = Call Restriction List, 3 = Do Not Disturb and Room Clean List, 4 = Message Waiting List, 5 = Wake Up Call List)</i>
--	--

Room-to-Room Call Restriction

Enable Room-to-Room Call Restriction for a guest's phone:	Lift handset + 135 + Extension . <i>The guest can not dial any other Hotel Mode extension.</i>
Disable Room-to-Room Call Restriction for a guest's phone:	Lift handset + 136 + Extension .

Single Digit Dialing

When a guest wants to use Single Digit Dialing:	Lift handset + single dial pad key (1-9).
---	--

Toll Restriction (When Checked In)

Change a room phone's Toll Restriction (When Checked In) level:	Lift handset + 137 + Extension to change the Toll Restriction (When Checked In) level + Enter the new Toll Restriction (When Checked In) level (01-15).
---	--

Wake Up Call

Set a Wake Up Call for your own room:	Lift handset + 131 + Time for wake up (use a 24-hour clock, ex: 1:00 PM = 13:00) + Hang up.
Cancel a Wake Up that you have set:	Lift handset + 132 .
Set a Wake Up Call for another room:	Lift handset + 133 + Extension to receive the wake up + Time for your wake up (use a 24-hour clock, ex: 1:00 PM = 13:00) + Hang up.
Cancel a Wake Up you have set for another room:	Lift handset + 134 + Extension whose wake up you want to cancel.





Section 2

Hotel/Motel Features

2

Start-Up Programming

For all hotel telephones (including supervisor's stations):

In **42-02-01 : Hotel/Mode Telephone Setup - Hotel Mode**, enter 1 for each Hotel/Motel extension port. This automatically designates the extension for Aspire Hotel/Motel operation.

System software 5.00 or higher is required for the Hotel/Motel feature.

Do Not Disturb



Do Not Disturb (DND) blocks a telephone’s incoming calls and Paging announcements. A guest can activate DND any time they need privacy (for example, if they need to work uninterrupted). Once a guest activates Do Not Disturb, they can still place calls and dial other hotel/motel services from their room telephone. Callers to the DND extension hear error tone or the voice prompt, “Please do not disturb” (if installed).

Supervisor’s stations can remotely activate and cancel Do Not Disturb for room telephones. If you allow room telephones to activate DND, you should also allow supervisor stations to remotely activate and cancel. Checking out a guest will also deactivate their phone’s Do Not Disturb.

When first installed . . .

- Do Not Disturb is disabled.

Using Do Not Disturb

To enable DND at a room telephone:

1. Lift handset.
2. Dial 127.

You hear confirmation tone after you dial the code.

3. Hang up.

The supervisor’s station can still call the extension by using the business mode feature Do Not Disturb Override.

To cancel DND at a room telephone phone:

1. Lift handset.

You hear stutter dial tone when you lift the handset.

2. Dial 128.

You hear confirmation tone.

3. Hang up.

To enable DND for another room telephone:

Normally, only the supervisor’s station has this capability.

1. Lift handset.
2. Dial 129.

3. Dial the number of the extension for which you want to enable DND.

You hear confirmation tone.

4. Hang up.

To cancel DND enabled at another room telephone:

Normally, only the supervisor’s station has this capability.

1. Lift handset.
2. Dial 130.

3. Dial the number of the extension for which you want to disable DND.

You hear confirmation tone.

4. Hang up.

Setting Up Do Not Disturb

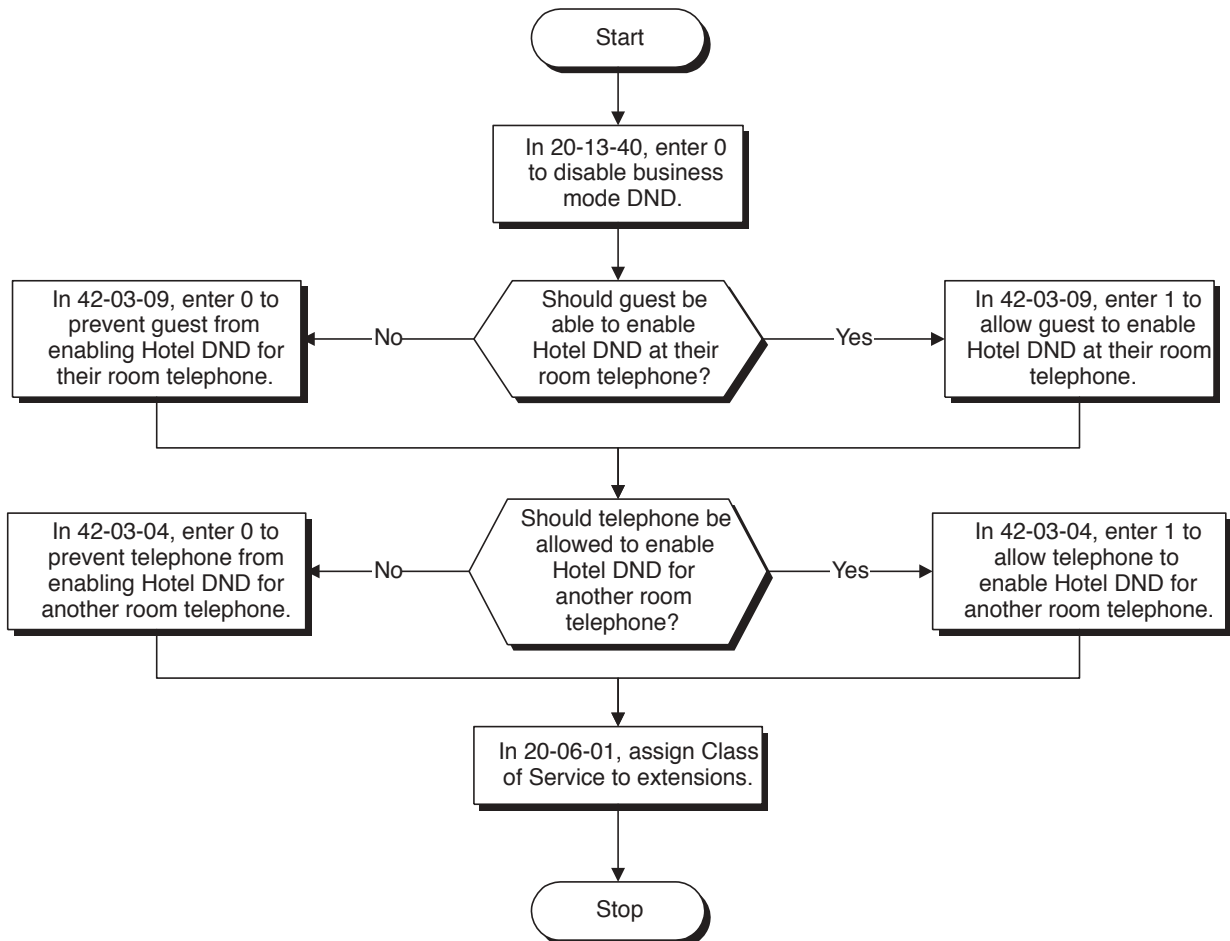

Programming

- **20-06-01 : Class of Service for Extensions**
Assign Class of Service (1-15) to extensions.
- **20-13-40 : Class of Service Options (Supplementary Service) - Do Not Disturb**
Allow (1) or prevent (0) the user from being able to use the business mode Do Not Disturb feature.
- **42-03-04 : Class of Service Options (Hotel/Motel) - DND Setting for Other Extension**
Use this option to enable (1) or disable (0) an extension’s ability to set Hotel DND for another extension. Normally, only the supervisor’s station would have this option enabled.
- **42-03-09 : Class of Service Options (Hotel/Motel) - DND Setting for Own Extension**
Use this option to enable (1) or disable (0) an extension’s ability to set Hotel DND for itself. If your guests should be able to turn DND on and off, be sure to enable this option.

DSS Console Monitoring

With a single press, see who has messages and Wake-Up Calls - and even their room's status.

The DSS Console provides the supervisor's station with unique one-touch room monitoring capabilities. Instead of relying on an elaborate off-line tracking system, the supervisor can just press a button on their DSS Console to see:

- Room telephones with messages waiting
- Room telephones that have Wake Up Calls set or missed
- The status of each room (Checked In, Checked Out, Maid Required, Maid in Room, or Ready to Inspect)

The DSS Console also gives the supervisor's station the full complement of business mode DSS Console features, including:

- One-button calling to extensions, Door Boxes and outside lines
- Busy Lamp Field (BLF) for extensions and Door Boxes
- Night Service Mode switching
- DSS Console Alternate Answer Activation
- One-button access to Service Codes and Programmable Feature Key codes

When first installed . . .

- DSS Consoles are not assigned. Refer to *Setting Up DSS Console Monitoring* (page 2-6) after plugging in the console.

Using DSS Console Monitoring

To check which room telephones have Messages Waiting:

1. Without lifting the handset, press **MESSAGE (PAGE)**.

<u>If the DSS Key is</u>	<u>The guest has</u>
ON	A Message Waiting
OFF	No messages

To check which room telephones have Wake Up Calls set:

1. Without lifting the handset, press **WAKE UP (GROUP)**.

<u>If the DSS Key is</u>	<u>The guest has</u>
ON	A Wake Up Call set
OFF	No Wake Up Call set
FAST FLASH	Wake Up Call missed

To view the Check Out Status of a room:

1. Without lifting the handset, press **STATUS (DOOR)**.

<u>If the DSS Key is</u>	<u>The guest has</u>
ON	Checked In and Clean
OFF	Checked Out (Clean and Available)
SLOW FLASH	Maid Required
MEDIUM FLASH	Maid in Room
FAST FLASH	Inspect

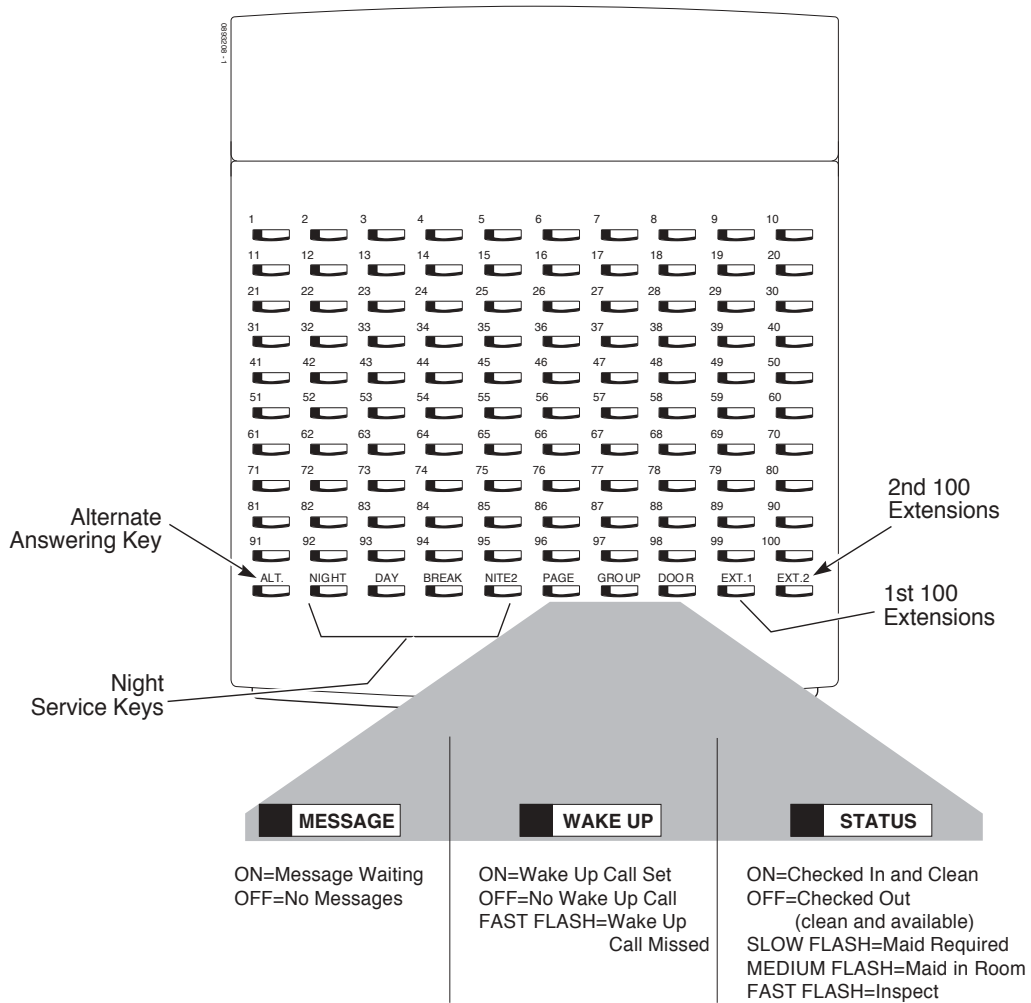

Setting Up DSS Console Monitoring

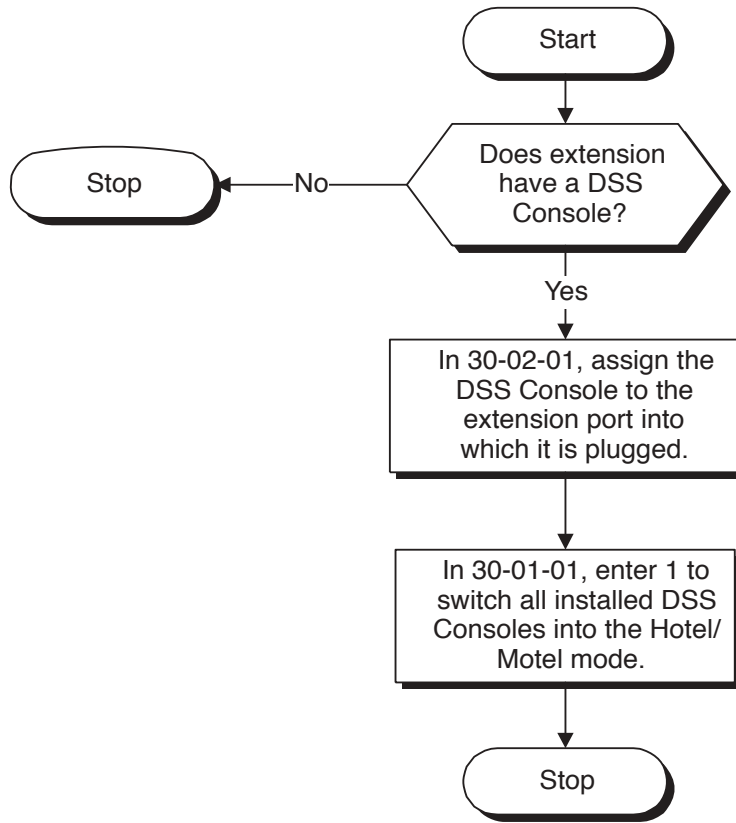

Programming

- **30-01-01 : DSS Console Operating Mode**
Enter 1 for this option to set all of the system’s DSS Consoles for Hotel/Motel operation. This redefines each console’s keys as follows:

This key in Business Mode	Has this function in Hotel/Motel Mode
PAGE	MESSAGE (Message Waiting)
GROUP	WAKE UP (Wake Up Calls)
DOOR	STATUS (Room Status)

- **30-02-01 : DSS Console Extension Assignment**
For the DSS Console Number you are programming (1-4 in Aspire S, 1-32 in Aspire M/L/XL), enter the number of the extension port into which the console is plugged. Remember, each extension/DSS Console combination is called a Console Number. Each Console Number can have up to four physical DSS Consoles. Refer to *Direct Station Selection (DSS) Console* in your system’s *Software Manual* for additional details.

Message Waiting

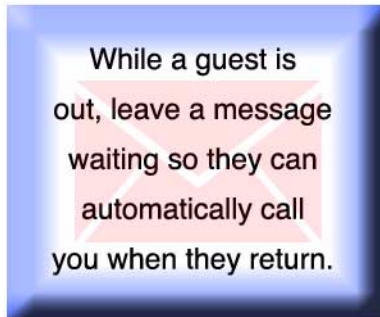

If you call a guest and they are away from their room, leave them a Message Waiting for a return call. When the guest returns, they will see the lamp on their phone flashing. To return the message, the guest just goes to the phone and dials the Message Waiting code. The system then automatically places a call to the extension that initially left the message.

Use Message Waiting when you have mail, parcels or other packages for a guest dropped off at your front desk. Instead of constantly redialing the room hoping to find the guest in, just send them a Message Waiting. In that way, you'll be sure to get a return call as soon as the guest arrives.

Note: An option is available for analog single line telephones with a display to allow for a Message Waiting indications.

When first installed . . .

- Any telephone can leave a Message Waiting at any other telephone.

Using Message Waiting

To leave a Message Waiting:

Normally, only the supervisor's station would have this capability.

1. Call the room telephone.
2. Dial 0.

You hear confirmation tones. The Message Waiting lamp on the telephone your called flashes.

3. Hang up.

If you want to cancel the message you just left, lift the handset and dial 873. If you know the number of the extension at which you left the message, dial 871 and that extension's number instead.

To Leave a Message Waiting Without First Calling the Extension:

The supervisor's station is typically the only phone with this capability.

1. Lift the handset.
2. Dial 126.
3. Dial the number of the room telephone at which you want to leave the message waiting.

You hear confirmation tones.

To answer a Message Waiting left at your phone:

Your Message Waiting lamp flashes when you have a message.

1. Lift the handset.
Listen for dial tone.

2. Dial *0.

You will automatically call the extension that left you a message.

Setting Up Message Waiting

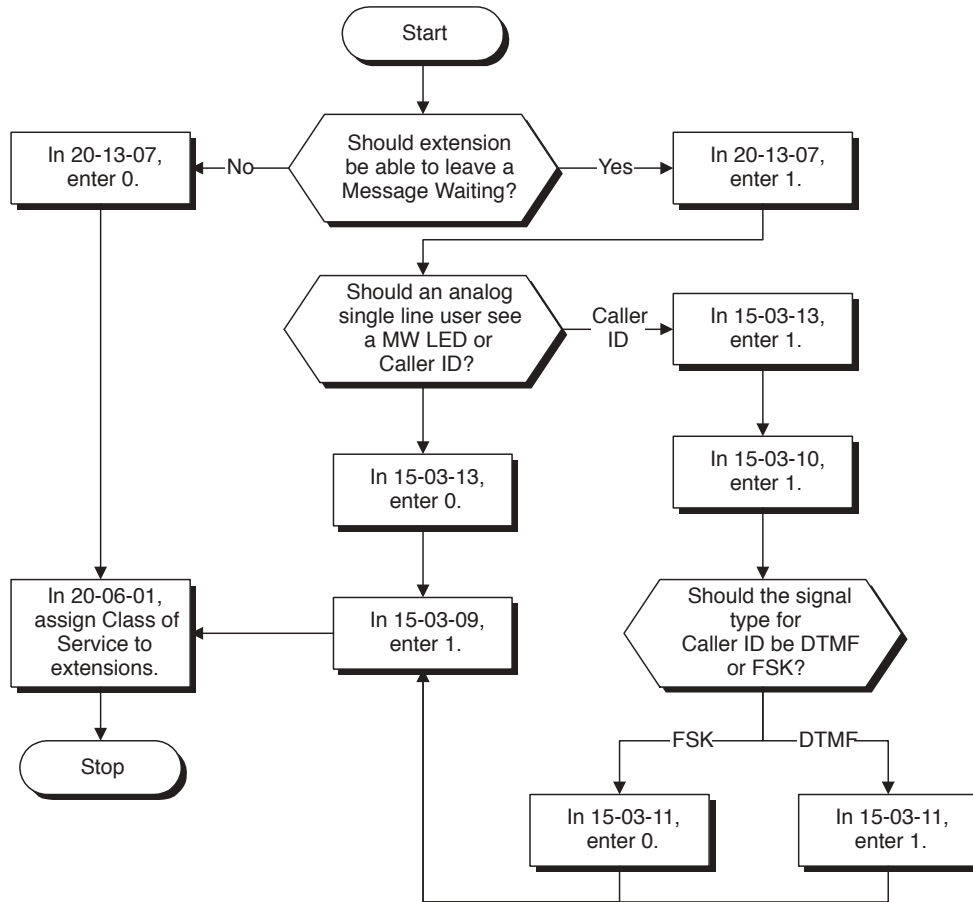

Programming

- **15-03-09 : Single Line Telephone Basic Data Setup - Caller ID Function - For External Module**
If a 3rd party display SLT phone is used, enable (1) Caller ID FSK signal in order to allow the phone to display Message Waiting indications.
- **15-03-10 : Single Line Telephone Basic Data Setup - Caller ID Name**
Enable (1) or disable (0) a display SLT’s ability to display the Caller ID Name.
- **15-03-11 : Single Line Telephone Basic Data Setup - Caller ID Type**
Select either FSK (0) or DTMF (1) as the Caller ID type to be received by the phone.
- **15-03-13 : Single Line Telephone Basic Data Setup - MW Signal Type**
Determine whether the SLT with a display with indicate a Message Waiting by the LED (0) or if Caller ID will be used to display the call (1).
- **20-06-01 : Class of Service for Extensions**
Assign Class of Service (1-15) to extensions.
- **20-13-07 : Class of Service Options (Supplementary Service) - Message Waiting**
Use this option to enable (1) or disable (0) an extension’s ability to leave a Message Waiting. Normally, only the supervisor’s station would have this option enabled.

Room Status



Use your phone and DSS Console to set and monitor the status of your guest rooms. Room Status helps you maximize room usage by coordinating your cleaning staff and reservation desk. Use simple codes to set a room's status. And, just press STATUS on your console to see the status of all your rooms at a single glance. (See *DSS Console Monitoring* (page 2-4) for more.)

2

There are four Room Status options:

Check-in Options

Check-in options override house cleaning options. Also, changing a room's check-in status affects Toll Restriction (When Checked In).

- **Checked In**

The guest has checked into the room.

This option is Room Clean on the Room Status Printout. Normally, only the front desk can use this option.

- **Checked Out**

The room is clean, checked out and available for a new guest. All house cleaning is complete.

This option is Inspection Required on the Room Status Printout. Normally, only the front desk can use this option.

House Cleaning Options

- **Maid Required**

The room is vacant, has been inspected and needs to be cleaned. The room is not checked out and available for a new guest.

This option is Maid Required on the Room Status Printout.

- **Maid in Room**

House cleaning is currently working in the room. The room is not checked out and available for a new guest.

This option is Maid in Room on the Room Status Printout.

When first installed . . .

- Setting Room Status is disabled for all telephones.

Using Room Status

Check-in Options

To set a room as checked in:

Set a room as checked in as the guest registers at the front desk.

1. Lift the handset.
2. Dial 138.
3. Dial the extension number of the room you want to check in.

You hear confirmation tone.

4. Hang up.

In the STATUS mode, the DSS Console key for the room is on.

To set a room as checked out:

Set a room as checked out after your guest checks out and the room is clean. You can set a room as checked out only if you have previously dialed 138 to check it in.

1. Lift the handset.
2. Dial 139.
3. Dial the extension number of the room you want to check out.

You hear confirmation tone.

4. Hang up.

In the STATUS mode, the DSS Console key for the room is off.

House Cleaning Options

To set a room's house cleaning status from the room telephone:

Your cleaning staff can set the room's status.

1. Lift the handset.
2. Dial 140.
3. Dial the room status code:
 - 1 = Room Clean (Occupied)
 - 2 = Maid Required
 - 3 = Maid in Room
 - 4 = Inspection Required

You hear confirmation tone.

4. Hang up.

In the STATUS mode, the DSS Console shows the room's status: slow flash for Maid Required; fast flash for Maid in Room.

To set a room's status from another telephone:

The supervisor's station should be the only telephone with this capability.

1. Lift the handset.
2. Dial 141.
3. Dial the extension number of the room you want to set.
4. Dial the room status code:
 - 1 = Room Clean (Occupied)
 - 2 = Maid Required
 - 3 = Maid in Room
 - 4 = Inspection Required

5. You hear confirmation tone.

6. Hang up.

In the STATUS mode, the DSS Console shows the room's status: slow flash for Maid Required; fast flash for Maid in Room.

Setting Up Room Status

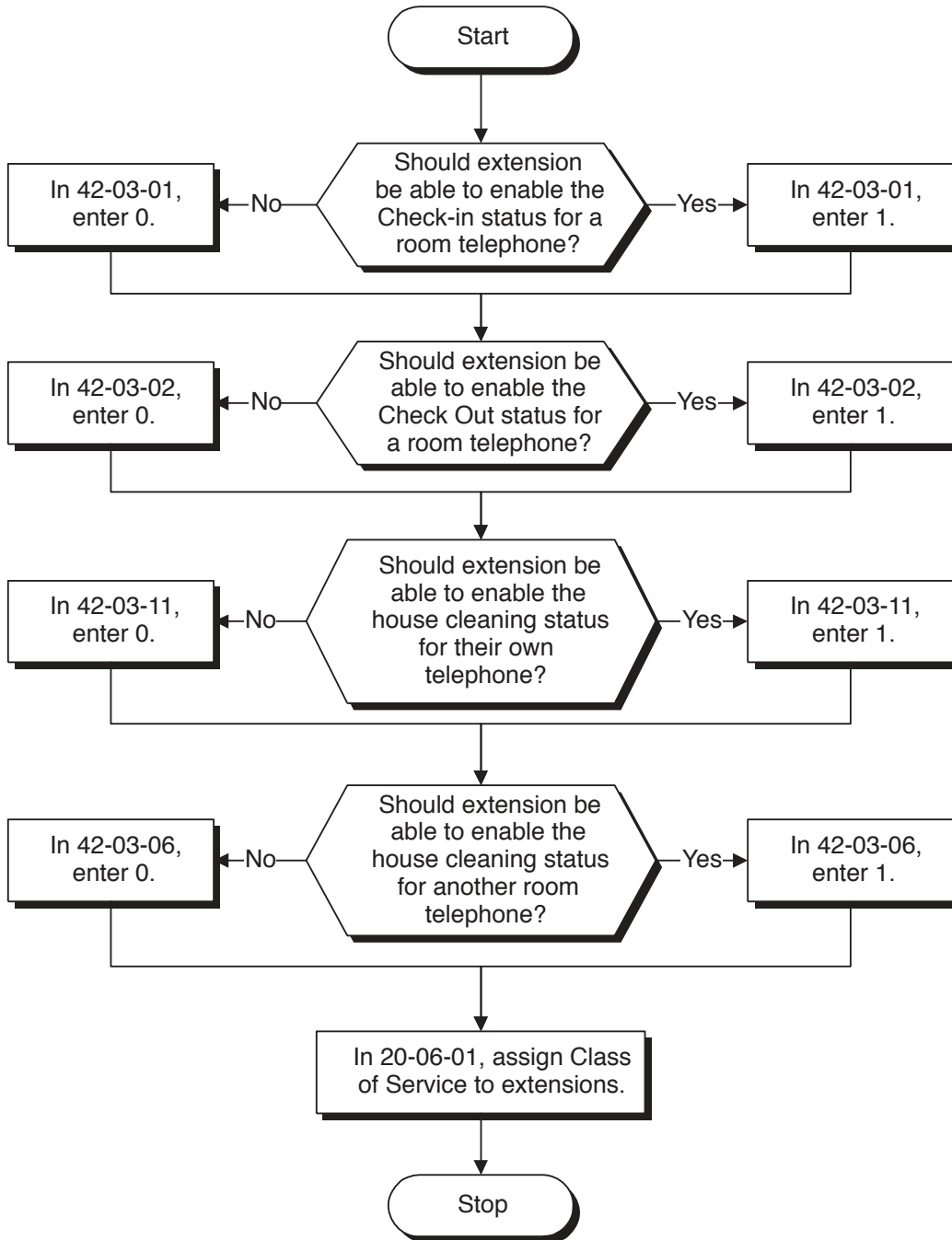

Programming

- **20-06-01 : Class of Service for Extensions**
Assign Class of Service (1-15) to extensions.
- **42-03-01 : Class of Service Options (Hotel/Motel) - Check-In Operation**
Use this option to enable (1) or disable (0) an extension's ability to set the check-in status of a room. Normally, only the supervisor's station would have this option enabled.
- **42-03-02 : Class of Service Options (Hotel/Motel) - Check-Out Operation**
Use this option to enable (1) or disable (0) an extension's ability to set the check-in status of a room. Normally, only the supervisor's station would have this option enabled.
- **42-03-06 : Class of Service Options (Hotel/Motel) - Room Status Change for Other Extension**
Use this option to enable (1) or disable (0) an extension's ability to change the house cleaning status of another room (Service Code 141). Normally, only the supervisor's station would have this option enabled.
- **42-03-11 : Class of Service Options (Hotel/Motel) - Room Status Change for Own Extension**
Use this option to enable (1) or disable (0) an extension's ability to change the house cleaning status of its own room (Service Code 140). If you enable this option, your cleaning staff can set a room's status as they leave the room.

Room Status Printouts



Use the Room Status Printouts to get a concise overview of the status of your guest rooms at a glance. The printouts give you up to the minute reports showing Check In Status, Room Call Restriction, Do Not Disturb, Message Waiting and Wake Up Calls. There are five separate reports available (shown below).

Room Status List (Option 1)

The Room Status List shows the status of each room. This gives you an overview of all your rooms in a single report. In the report below:

- Room Cleanlists all the Checked In rooms (311, 311 and 315).
- Maid Requiredlists all the vacant rooms that need cleaning (309).
- Maid in Roomlists the rooms in which house cleaning is currently working (317).
- Inspection Requiredlists the rooms that are Checked Out waiting to be cleaned up (313).



Room Status List	-----	03/03/06	12:15
Room Clean (Occupied) --- Check In			
305	311	315	
Maid Required			
309			
Maid in Room			
317			
Inspection Required			
313			

Call Restriction List (Option 2)

The Call Restriction List shows the status of Room-to-Room Call Restriction and Toll Restriction at each phone. In the following report:

- Room-to-Room Barring . . shows which extensions have Room-to-Room Call Restriction enabled (311).
- Outside Call Class lists the Toll Restriction Level for each extension. If an extension is checked in, this report shows the *Toll Restriction When Checked In* level. If the extension is checked out, this report shows the business mode Toll Restriction level.

Calling Class List	-----	03/03/06	12:15
Room to Room Barring			
311			
Outside Call Class			
305 -05	309 -01	311 -03	

Do Not Disturb and Room Clean List (Option 3)

This report shows two things: Rooms in Do Not Disturb and rooms with a house cleaning option enabled. This is an important report for the cleaning staff. The first section of the report shows the rooms that should not be disturbed for any reason. The second section of the report shows rooms that need to be cleaned and rooms that housecleaning is currently cleaning.

- *Do-Not Disturb* . . . Lists all the rooms that have enabled Do Not Disturb (305).
- *Clean Up Check* . . . Provides a summary report of rooms that are unavailable because they are either checked in or checked out (311). You may want to check these rooms to see if they need cleaning. Rooms not in this report are unoccupied and available.

DND and Clean Up Check	-----	03/03/06	12:15
DO-NOT-DISTURB			
309			
CLEAN UP CHECK			
313			

Message Waiting List (Option 4)

This report lists all the rooms that have Messages Waiting (307 and 311). Be sure to clear the Messages Waiting for all rooms that are checked out or available (clean).

Message Service List	-----	03/03/06	12:15
307	311		

Wake Up Call List (Option 5)

This report lists all the rooms that have Wake Up calls (307, 311 and 339) and shows the time set for each call. An asterisk (*) in front of the extension number indicates that the Wake Up Call was unanswered. Consider checking on the guests that have unanswered Wake Up Calls.

Wake Up Call List	-----	03/03/06	07:15
307	-07:55	*311	-6:55
		339	-07:15

Note: Room Status Reports require a CTA Adapter and a compatible printer. Refer to the *Data and SMDR* section in your system’s Hardware Manual for more

When first installed . . .

- Requesting the Room Status Printout is disabled for all telephones.

Using Room Status Printouts

To have your printer output the Room Status Printout:

Your printer should be location conveniently next your phone.

1. Lift the handset.
2. Dial 142.
3. Dial the Room Status Printout option:
 - 0 = All Printouts
 - 1 = Room Status List (Check-in and House Cleaning Status)
 - 2 = Call Restriction List
 - 3 = Do Not Disturb and Room Clean List
 - 4 = Message Waiting List
 - 5 = Wake Up Call List
4. Hang up.

Setting Up Room Status Printouts

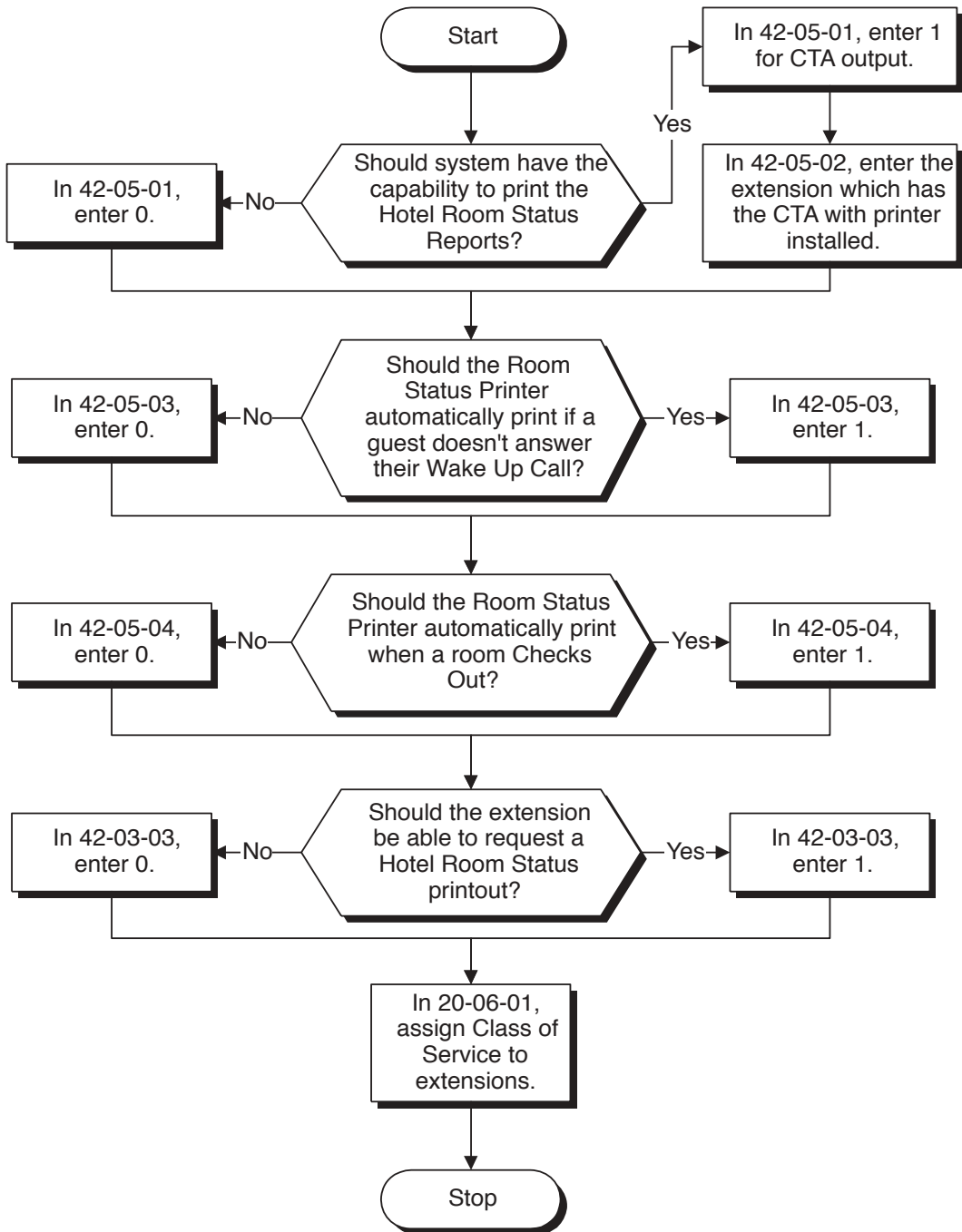

Programming

- **20-06-01 : Class of Service for Extensions**
Assign Class of Service (1-15) to extensions.
- **42-05-01 : Hotel Room Status Printer - Output Port Type**
Use this option to set the CTA output (1) to request Room Status Printouts. In most cases, only the supervisor's station would have this capability.
- **42-05-02 : Hotel Room Status Printer - Output Destination Number**
Assign the CTA port which will be used for the status report printer.
- **42-05-03 : Hotel Room Status Printer - Wake Up Calls**
Enable this option (1) to have unanswered Wake Up Calls automatically print on the Room Status Printer. Disable this option (0) if you don't want unanswered Wake Up Calls to print.
- **42-05-04 : Hotel Room Status Printer - Check Out**
Enable this option (1) if you want to have the Room Status Printer automatically print when a room Checks Out. Disable this option (0) if you don't want the Room Status Printer to automatically print Check Outs.

Room-to-Room Call Restriction



Room-to-Room Call Restriction prevents guests in one room from calling guests in another. You'll find this restriction handy for guests that want to maintain their privacy. On the other hand, you may want to allow inter-room calling for families or groups that have separate rooms.

When first installed . . .

- Room telephones are not restricted from calling other room telephones.
- An extension cannot enable Room-to-Room Call Restriction for a room telephone.

WARNING

If you enable Room-to-Room Call Restriction for a guest's phone, neither you nor any other Hotel Mode extension can call them while they are checked in. **To call the guest's phone, first dial 136 to cancel the restriction.** This may have implications in emergency situations.

Note: Checking out a room (by dialing Service Code 139) automatically cancels Room-to-Room Call Restriction.

Using Room-to-Room Call Restriction

To enable Room-to-Room Call Restriction for a guest's phone:

1. Lift the handset.
2. Dial 135.
3. Dial the guest's phone number.
You hear confirmation tone.

The guest can not dial any other Hotel Mode extension. Consider having a single emergency phone that is not set for Hotel Mode (e.g., the operator). The guest will always be able to call that phone, even with restriction enabled.

To disable Room-to-Room Call Restriction for a guest's phone.

1. Lift the handset.
2. Dial 136.
3. Dial the guest's phone number.
You hear confirmation tone.

Setting Up Room-to-Room Call Restriction

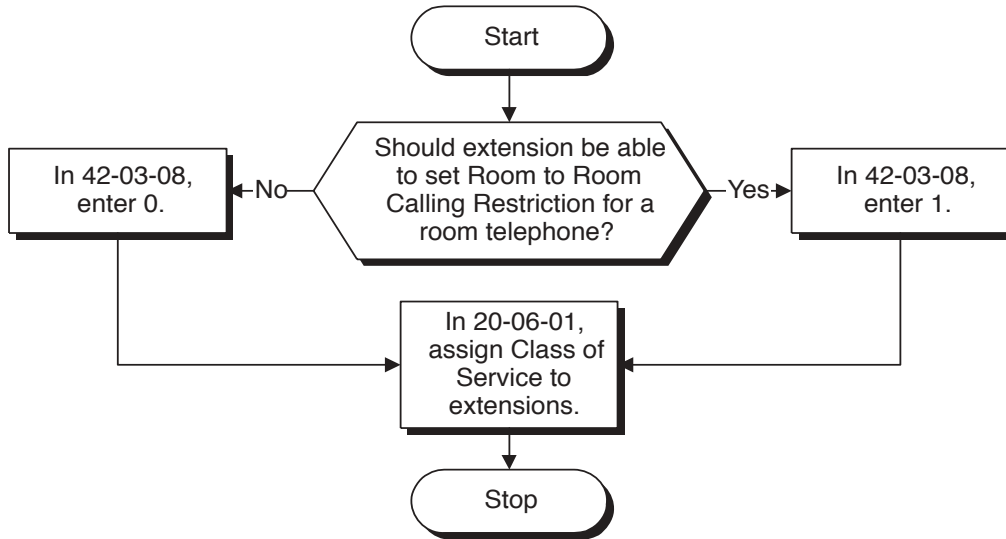

Programming

- **20-06-01 : Class of Service for Extensions**
Assign Class of Service (1-15) to extensions.
- **42-03-08 : Class of Service Options (Hotel/Motel) - Room-to-Room Call Restriction**
Use this option to enable (1) or disable (0) an extension’s ability to set Room-to-Room Call Restriction for another extension. In most cases, only the supervisor’s station would have this capability.

Single Digit Dialing

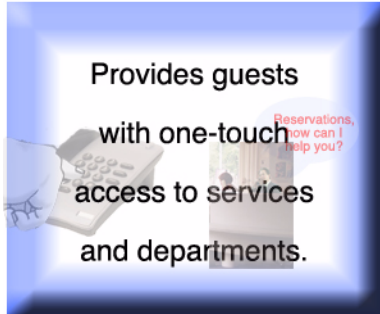

Single Digit Dialing gives your guests one-touch access to your important Hotel/Motel services. Rather than having your guests dial longer codes for services and departments, they can just lift the handset and press a single key. The Single Digit Dialing codes can be:

- **Extension numbers**

You can give you guests one-touch access to the front desk, reservation services, housekeeping or the maitre d' of your restaurant. You won't have to publish an in-room directory of extension numbers for these services. The press of a single key automatically dials the assigned extension number.

- **Feature access codes**

Storing feature access codes gives you great flexibility in how you want your guest phones to work. For example, you could have your guests dial 6 for local calls. The digit 6 could output 8041, which is the access code for trunk group 1. Or, you could program the code 5 to automatically leave a Message Waiting at the maintenance office. In this example, dialing 5 could output 3050 which would leave a Message Waiting at extension 305. Refer to the *Service Codes Tables* in your Software Manual for more on your Feature Access Codes.

- **Voice Mail**

If you have mailboxes for your services (such as housekeeping), your guests can leave requests even when the service providers are unavailable. You won't miss the requests and your guests will appreciate the convenience. Refer to *Voice Mail* in your Software Manual for more information about Voice Mail.

- **A Department Calling Group**

If you have several agents with extensions at your reservation desk, you could program them into a unique Department Calling Group. Then, assign a single digit to access the pilot number of the group. When a guest dials the digit, they go through to the first available agent. Refer to *Department Calling* in your Software Manual for additional details on Department Calling Groups.

When first installed . . .

- No Single Digit Dialing codes programmed.

Using Single Digit Dialing

When a guest wants to use Single Digit Dialing:

1. They just lift the handset and press a single dial pad key (1-9).

Setting Up Single Digit Dialing

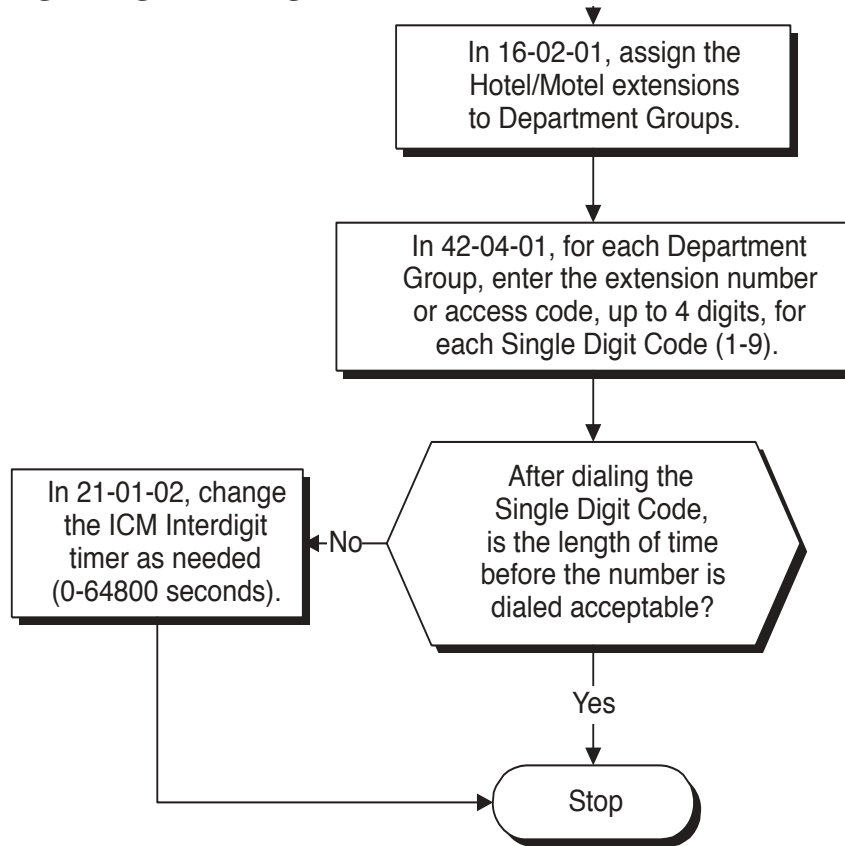

Programming

- **16-02-01 : Department Group Assignment for Extensions**
Assign extensions to Department Groups (Aspire S:1-8 or Aspire M/L/XL: 1-64) and set the priority assignment.
- **21-01-02 : System Options for Outgoing Calls - Intercom Interdigit Time**
Set the Intercom Interdigit time (0-64800 seconds). When placing ICM calls, users must dial each digit within this interval. With Single Digit Dialing, dialing the programmed code will occur after this timer expires.
- **42-04-01 : Hotel Mode One-Digit Service Codes**
For each Department Calling Group, enter the destination for each Single Digit Code (1-9). The destination can be any code up to four digits long, such as an extension number or access code. (You cannot make single digit entries for codes 0, # and *.)

Toll Restriction (When Checked In)



With Toll Restriction (When Checked In), you can control your guest’s long distance dialing automatically when they check in. This option allows you to set up two completely different Toll Restriction modes. The first mode determines the types of calls your staff can place from a room telephone when the room is checked out (Service Code 139). This is the business mode Toll Restriction. The second mode sets the Toll Restriction limits for your guests as soon as you check them in (Service Code 138). This is the hotel mode Toll Restriction.

In the checked out mode, for example, you may want to allow your staff to call locally and within your area code. This would allow them to contact suppliers and other service providers without going to the front desk each time. In the checked in mode, however, you may want to completely restrict outgoing calls and force your guests to use your metered services. (This can also tie into *Single Digit Dialing* (page 2-19).)

In many cases, such simplified Toll Restriction scenarios may be adequate. However, since each mode uses the full capabilities of the system’s Toll Restriction programming, you can make the calling restriction as elaborate as you need it to be.

Toll Restriction (When Checked In) also allows you to change the Toll Restriction level of a room telephone *while* the room is checked in. This allows you to provide more permissive Toll Restriction to high priority guests. It also allows you to enforce less permissive dialing privileges to guests if you suspect the potential for abuse.

The following diagram shows the basic operation of Toll Restriction (When Checked In). When checked in, the room telephone follows the Check In Toll Restriction Level (set in Program 42-02-02). When checked out, the room telephone follows the normal Toll Restriction Level (set in Program 21-04-01). Both levels interact with the dialing restrictions set up in Program 21-05 and 21-06. For more details, see *Setting Up Toll Restriction (When Checked In)* (page 2-22).

When first installed . . .

- All room telephones can make unrestricted outgoing calls.

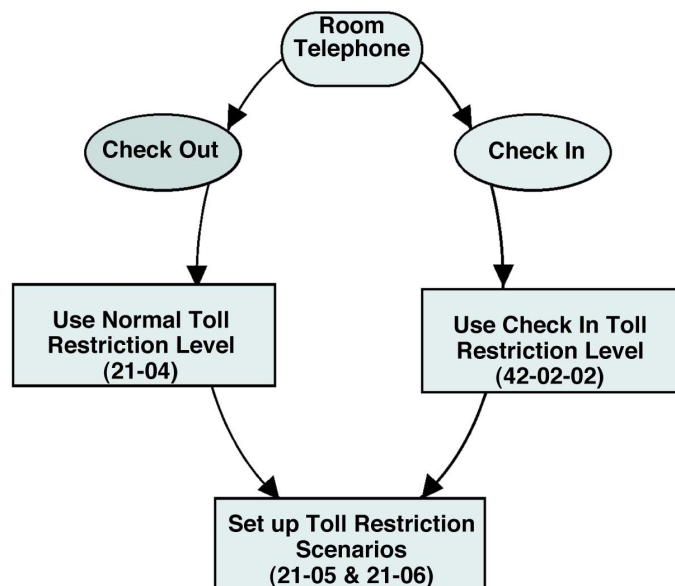

Using Toll Restriction (When Checked In)

To change a room telephone's Toll Restriction (When Checked In) level:

1. Lift the handset.
2. Dial 137.
3. Dial the number of the extension for which you want to change the Toll Restriction (When Checked In) level.
You hear a single beep.
4. Enter the new Toll Restriction (When Checked In) level (01-15).
You hear confirmation tone.



Setting Up Toll Restriction (When Checked In)

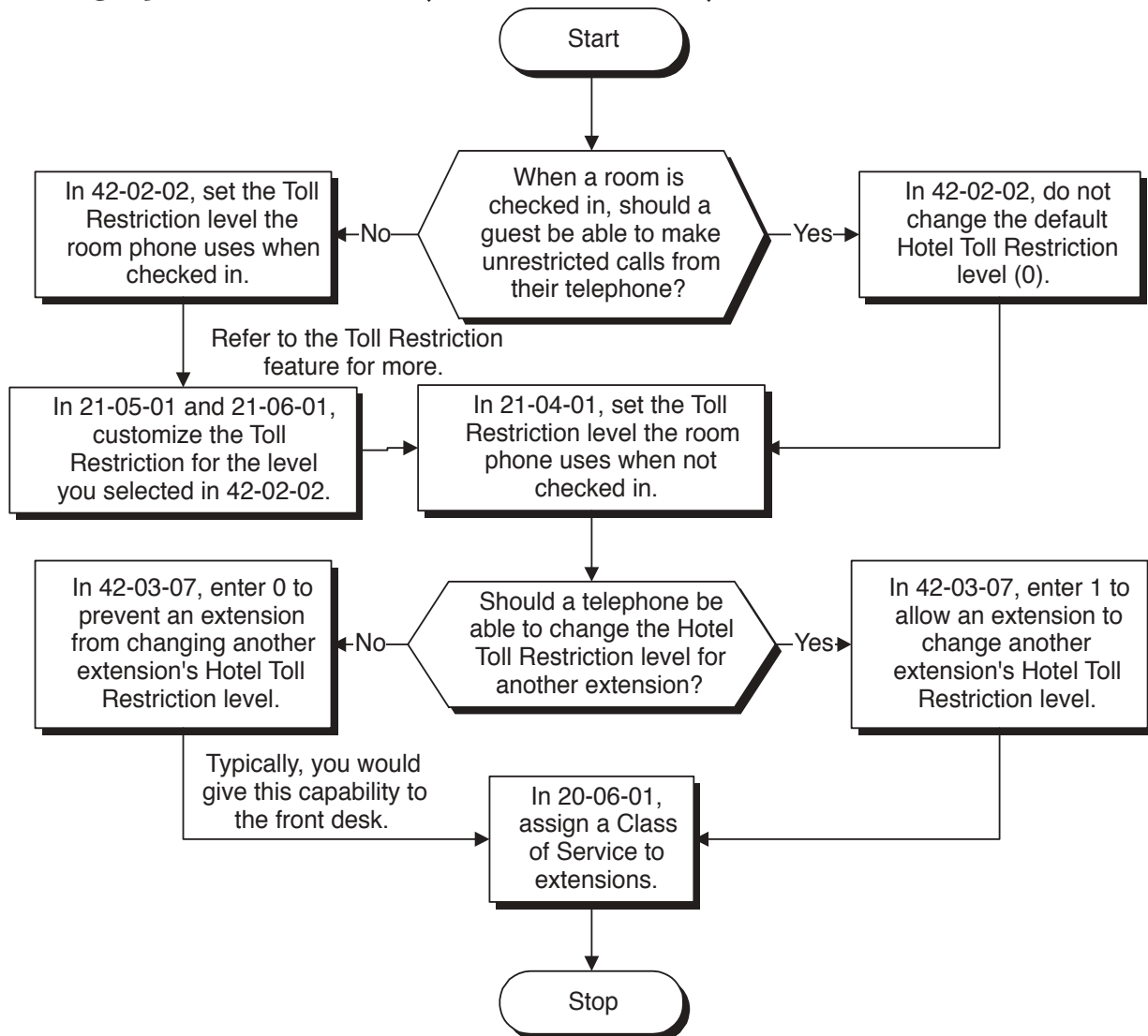

Programming

- **20-06-01 : Class of Service for Extensions**
Assign Class of Service (1-15) to extensions.
- **21-05-01 - 21-05-15 : Toll Restriction Class**
For each Toll Restriction Class assigned to an extension in Program 21-04, enable or disable the different Toll Restriction Tables set up in Program 21-06. This sets up the Toll Restriction scenarios for room telephones when they are *not* checked in. Refer to your Software Manual for additional information on this program.
- **21-06-01 - 21-06-10 : Toll Restriction Table Data Setup**
Set up the various Toll Restriction Tables and options. Once set up, you assign the tables and options to Toll Restriction Classes in Program 21-05. In addition, you assign extensions to Toll Restriction Classes in Program 21-04. This sets up the Toll Restriction scenarios for room telephones when they are *not* checked in. Refer to your Software Manual for additional information on this program.
- **21-04-01 : Toll Restriction Class for Extensions**
Use this program to assign extensions to Toll Restriction Classes. In Program 21-05, you assign the various options set up in Program 21-06 to the classes assigned in Program 21-04. This sets up the Toll Restriction scenarios for room telephones when they are *not* checked in. Refer to your Software Manual for additional information on this program.
- **42-02-02 : Hotel/Motel Telephone Setup - Toll Restriction Class On Check In**
When a room telephone is checked in, it uses the Toll Restriction Level assigned in this program. You would generally have different entries for Program 21-04 and Program 42-02-02. This would allow you to have more dialing restrictions when a room is checked in — and more lenient dialing restrictions once a guest checks out.
Station Restriction Codes dialed by the supervisor permanently override this option.
- **42-03-07 : Class of Service Options (Hotel/Motel) - Toll Restriction Class Changing for Other Extension**
Use this option to enable (1) or disable (0) an extension's ability to set the Toll Restriction Level (When Checked In) for another extension. In most cases, only the supervisor's station would have this capability.

Wake Up Call



Have your guests set their Wake Up Calls - or you can set Wake Ups for them.

A Wake Up Call is like an alarm clock: just set it and it will alert the guest at prescribed time. But unlike a simple alarm clock, Wake Up Call has some unique advantages:

- Guests can set or cancel Wake Up Calls for themselves, or you can set and cancel Wake Ups for them.
- When a guest answers their Wake Up Call, you can have the system play them Music on Hold, a prerecorded message, or a prerecorded message followed by the time. If you choose the message or message/time option, your system will repeat the message three times and then cancel the Wake Up Call. (This option is only available from analog single line telephones.)
- You can view the status of all the wake ups from your DSS Console. Just press WAKE UP to see which rooms have reminders set. Refer to *DSS Console Monitoring* (page 2-4) for more.
- Optionally have *unanswered* Wake Up Calls call the operator and print on the Room Status Printout report. This helps you find out who needs another reminder or might need assistance. See **Room Status Printouts** (page 2-13) for more on the printed report.
- Use Wake Up Call as a meeting reminder for convention attendees. If the meeting time gets changed, you can reset the reminder for all attendees.

Up to a maximum of 16 telephones can be set for the same time. If more than 16 telephones are set for the same time, the time for the Wake Up Call for those additional phones will be moved to the next minute.

When a guest answers their Wake Up Call, you can choose to play either Music on Hold or a VRS message as set in Program 42-01-01 and 42-01-02. If the system is set for the VRS message and the VRS is not available (connect connected, busy or Program 42-01-02 is set to “0”), Music on Hold will be played instead.

When first installed . . .

- No guests can set Wake Up Calls. In addition, no extensions can set wake up calls for other extensions.

Using Wake Up Call

To set a Wake Up Call for your own room:

1. Lift the handset.
2. Dial 131.
3. Dial the time for your wake up.
Use a 24-hour clock. For example, 1:00 PM = 13:00. You hear confirmation tone.
4. Hang up.

To cancel a Wake Up that you have set:

1. Lift the handset.
2. Dial 132.
You hear confirmation tone.

To set a Wake Up Call for another room:

Normally, only the supervisor's station would have this capability.

1. Lift the handset.
2. Dial 133.
3. Dial the number of the room phone that should receive the wake up.
4. Dial the time for your wake up.
Use a 24-hour clock. For example, 1:00 PM = 13:00. You hear confirmation tone.
5. Hang up.

To cancel a Wake Up you have set for another room:

1. Lift the handset.
2. Dial 134.
3. Dial the number of the room phone whose wake up you want to cancel.
You hear confirmation tone.

Setting Up Wake Up Call

2

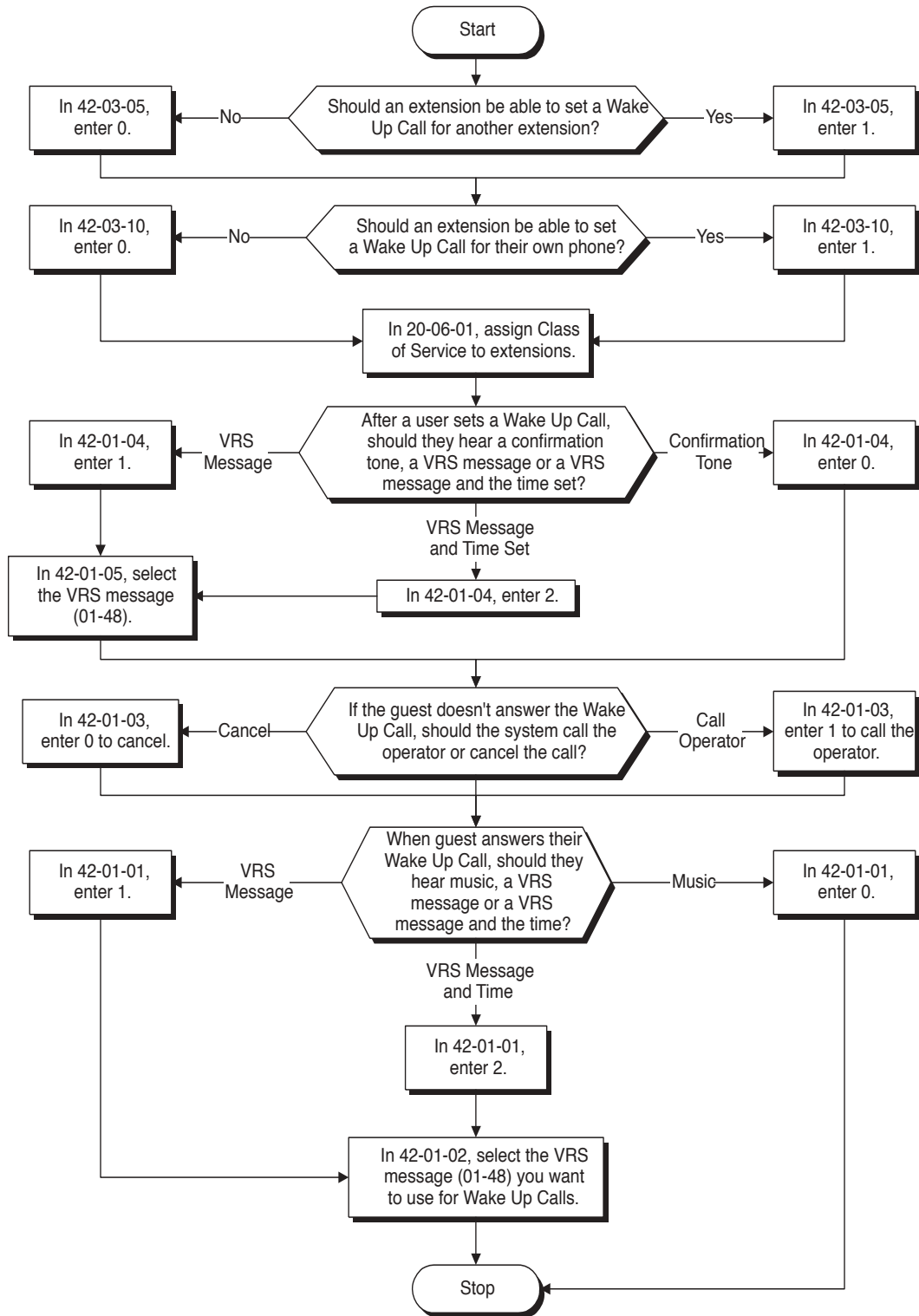

Programming

- **20-06-01 : Class of Service for Extensions**
Assign Class of Service (1-15) to extensions.
- **42-01-01 : System Options for Hotel/Motel - Answering Message Mode for Wake Up Call (Hotel Mode)**
Select the Hotel Wake Up Call mode: 0 = Music on Hold, 1 = VRS Message (specified in Program 42-01-02), or 2 = VRS Message (specified in Program 42-01-02) followed by the time programmed.
- **42-01-02 : System Options for Hotel/Motel - Wake Up Call Message Assignment**
Assign the VRS Message (01-48) used for Wake Up Calls. You need to program this option only if you have enabled mode 1 or 2 in Program 42-01-01 above.
- **42-01-03 : System Options for Hotel/Motel - Wake Up Call No Answer**
Enter 1 to have an extension automatically call the operator if they don't answer their Wake Up Call. Enter 0 to disable this option.
- **42-01-04 : System Options for Hotel/Motel - Setup Message Mode for Wake Up Call**
Determine what the user will hear after setting a Wake Up message (0=Confirmation Tone, 1 = VRS Message (specified in Program 42-01-05), 2 = VRS Message (specified in Program 42-01-05) followed by the time programmed).
- **42-01-05 : System Options for Hotel/Motel - Wake Up Call Message Assignment on Setup**
Assign the VRS Message (01-48) heard after programming Wake Up Calls. You need to program this option only if you have enabled mode 1 or 2 in Program 42-01-04 above.
- **42-03-05 : Class of Service Options (Hotel/Motel) - Wake Up Call Setting for Other Extension**
In an extension's Class of Service, enable (1) or disable (0) the ability to set a Wake Up Call for another extension. You should give this capability to the supervisor's station. It is inappropriate for most other extensions.
- **42-03-10 : Class of Service Options (Hotel/Motel) - Wake Up Call Setting for Own Extension**
In an extension's Class of Service, enable (1) or disable (0) the ability to set their own Wake Up Call. Most guests would appreciate this capability.

- For Your Notes -

2

Section 3

Programming Procedures

3

Before You Start Programming

This section provides you with detailed information about the system's Hotel/ Motel programs. By changing a program, you change the way the Hotel/Motel feature associated with that program works. In this section, you find out about each program, the features that the program affects and how to enter the program data into system memory.

Do not start customizing your Hotel/Motel features without first reading Section 2, Features.

When you want to customize a Hotel/Motel feature, find it in Section 2 and learn about it. Section 2 will tell you what programs you have to change to get the operation you want. Then, look the program up in this section if you have any questions about how to enter the data.

How to Use This Section

This section lists all the Hotel/Motel programs in numerical order. For example, Program 11-01 is at the beginning of the section and Program 90-11 is at the end. The information on each program is subdivided into the following headings:

Description describes what the program options control. The Default Settings for each program are also included. When you first install the system, it uses the Default Setting for all programs. Along with the Description are the *Conditions* which describe any limits or special considerations that may apply to the program.

The reverse type (white on black) just beneath the Description heading is the program's access level. You can only use the program if your access level meets or exceeds the level the program requires. Refer to **How to Enter the Programming Mode** (page 3-4) for a list of the system's access levels and passwords.

Feature Cross Reference provides you with a table of all the features affected by the program. You'll want to keep the referenced features in mind when you change a program. Customizing a feature may have an effect on another feature that you didn't intend.

Telephone Programming Instructions shows you how to enter the program's data into system memory. For example:

1. Enter the programming mode.
2. 15-07-01



```
15-07-01 TEL
KY01 = *01
```

tells you to enter the programming mode, dial 150701 from the telephone dial pad. After you do, you'll see the message "15-07-01 TEL301" on the first line of the telephone display. This indicates the program number (15-07), item number (01), and that the options are being set for extension 301. The second row of the display "KY01 = *01" indicates that Key 01 is being programmed with the entry of *01. The third row allows you to move the cursor to the left or right, depending on which arrow is pressed. To learn how to enter the programming mode, see **How to Enter the Programming Mode** (page 3-4) below.

How to Enter the Programming Mode

To enter the programming mode:

1. Go to any working display telephone.
In a newly installed system, use extension 301 (port 1).
2. Do not lift the handset.
3. Press CALL1.
4. # * # *

Password

5. Dial the system password + HOLD.

Refer to the following table for the default system passwords. To change the passwords, use Program 90-02.

Password	User Name	Level	Programs at this Level
374772	NEC-I	1 (MF)	All programs
12345678	ASPIRE	2 (IN)	All programs in this section not listed below for SA and SB
0000	ADMIN1	3 (SA)	10-01, 10-02, 10-12, 10-13, 10-14, 10-15, 10-16, 10-17, 10-18, 10-22, 12-02, 12-03, 12-04, 15-01, 15-07, 15-09, 15-10, 15-11, 20-16, 21-07, 21-14, 22-04, 22-11, 25-08, 30-03, 32-02, 40-02, 41-02, 41-03, 41-04, 41-05, 41-06, 41-07, 41-08, 41-09, 41-10, 41-11, 41-12, 41-13, 41-14, 41-15, 41-16, 41-17, 41-18, 90-03, 90-04, 90-06, 90-07, 90-18, 90-19
9999	ADMIN2	4 (SB)	13-04, 13-05, 13-06

Note: When changes are made to the following programs, the Aspire system must be restarted.

10-12-01	10-14	80-01	84-03-01	84-05-02	84-06-07
10-12-02	10-15	80-02-01	84-03-02	84-06-01	84-06-08
10-12-03	10-16-01	80-02-02	84-03-06	84-06-02	84-06-09
10-12-04	10-16-02	80-02-03	84-03-07	84-06-03	84-06-10
10-13-01	10-16-03	80-02-04	84-03-08	84-06-04	84-06-11
10-13-02	10-16-04	80-03	84-04	84-06-05	84-09
10-13-03	20-01-03	80-04	84-05-01	84-06-06	84-10

How to Exit the Programming Mode

To exit the programming mode:

When you are done programming, you must be out of a program's options to exit (pressing the MSG key will exit the program's option).

1. Press MSG key to exit the program's options, if needed.

```
Program Mode
Base Service OP1 OP2
```

2. Press SPK. You see, "Saving System Data" if changes to were to the system's programming.
3. The display shows "Complete Data Save" when completed and will exit the phone to an idle mode.

To save a customer's database, a blank PC-ATA card or CompactFlash with PCMCIA Adapter is required. Insert the card into the NTCPU and, using Program 90-03, save the software to the PC-ATA/CompactFlash card. (Program 90-04 is used to reload the customer data if necessary.) Note that a PC-ATA/CompactFlash card can only hold one customer database. Each database to be saved will require its own separate card.

Using Keys to Move Around in the Programs

Once you enter the programming mode, use the keys in the following chart to enter data, edit data and move around in the menus.

Keys for Entering Data	
Use this key...	When you want to . . .
0-9 and *	Enter data into a program.
HOLD	Complete the programming step you just made (like pressing Enter on a PC keyboard). When a program entry displays, press HOLD to bypass the entry without changing it.
CONF	Delete the entry to the left (like pressing Backspace on a PC keyboard).
MSG	Exit one step at a time from the program window currently being viewed. For example, if you're programming item 5 in 15-03, pressing MSG will allow you to enter a new option in program 15-03. Pressing MSG again will allow you to select a new program in the 15- series. Pressing MSG a third time will allow you to enter a new program beginning with '1'. Pressing MSG one last time will bring you to the beginning program display, allowing you to enter any program number.
FLASH	Switch extension, line, etc. being programmed by pressing FLASH. The cursor moves up to the top row of the display. Pressing FLASH again moves the cursor back to the middle row.
LINE KEYS	Use pre-programmed settings to help with the program entry. These settings vary between programs from LINE 1 = 0 (off) and LINE 2 = 1 (on) to preset values for timers where LINE 1 = 5, LINE 2 = 10, LINE 3 = 15, etc. For programs with this option, the line key which currently matches the programmed setting will light steady. The display may also indicate Soft Keys which will allow you to select the values as well (-1 and +1 will step through these pre-programmed settings.)
LINE KEY 1	Program a pause into an Abbreviated Dialing bin.
LINE KEY 2	Program a recall/flash into an Abbreviated Dialing bin.
LINE KEY 3	Program a @ into an Abbreviated Dialing bin.
VOL ▲	Scroll backward through a list of entry numbers (e.g., from extension 301 to 302, 303, etc.) or through entries in a table (e.g., Common Permit Table). <i>If you enter data and then press this key, the system accepts the data before scrolling forward.</i>
VOL ▼	Scroll forward through a list of entry numbers (e.g., from extension 301 to 302, 303, etc.) or through entries in a table (e.g., Common Permit Table). <i>If you enter data and then press this key, the system accepts the data before scrolling backward</i>

Programming Names and Text Messages

Several programs (e.g., Program 20-16: Selectable Display Messages) require you to enter text. Use the following chart when entering and editing text. When using the keypad digits, press the key once for the first character, twice for the second character, etc. For example, to enter a C, press key “2” three times. Press the key six times display the lower case letter. The name can be up to 12 digits long.

Use this keypad digit . . .	When you want to . . .
1	Enter characters: 1 @ [¥] ^ _ ` { } → ← Á À Â Ã Ç É Ê ì ó
2	Enter characters A-C, a-c, 2.
3	Enter characters D-F, d-f, 3.
4	Enter characters G-I, g-i, 4.
5	Enter characters J-L, j-l, 5.
6	Enter characters M-O, m-o, 6.
7	Enter characters P-S, p-s, 7.
8	Enter characters T-V, t-v, 8.
9	Enter characters W-Z, w-z, 9.
0	Enter characters: 0 ! “ # \$ % & ’ () ô o ú ä ö ü α ε θ
*	Enter characters: * + , - . / : ; < = > ? π Σ σ Ω ∞ ϕ ε
#	# = Accepts an entry (only required if two letters on the same key are needed - ex: TOM). Pressing # again = Space. (In system programming mode, use the right arrow soft key instead to accept and/or add a space.)
CONF	Clear the character entry one character at a time.
CLEAR	Clear all the entries from the point of the flashing cursor and to the right.

When using i-Series telephones on the Aspire system, not all the same characters are available. Refer to the following chart for the i-Series characters:

Use this keypad digit . . .	When you want to . . .
1	Enter characters: 1 @ [¥] ^ _ ` { } → ← å blank blank blank blank blank blank blank blank
2	Enter characters A-C, a-c, 2.
3	Enter characters D-F, d-f, 3.
4	Enter characters G-I, g-i, 4.
5	Enter characters J-L, j-l, 5.
6	Enter characters M-O, m-o, 6.
7	Enter characters P-S, p-s, 7.
8	Enter characters T-V, t-v, 8.
9	Enter characters W-Z, w-z, 9.
0	Enter characters: 0 ! “ # \$ % & ’ () blank blank blank ä ö ü α ε θ
*	Enter characters: * + , - . / : ; < = > ? π ∑ σ Ω ∞ ϕ £
#	# = Accepts an entry (only required if two letters on the same key are needed - ex: TOM). Pressing # again = Space.
CONF	Clear the character entry one character at a time.
CLEAR	Clear all the entries from the point of the flashing cursor and to the right.

3

Using Soft Keys For Programming

Each Aspire display telephone provides interactive soft keys for intuitive feature access. The options for these keys will automatically change depending on where you are in the system programming. Simply press the Soft Key located below the option you wish and the display will change accordingly.



Pressing the VOLUME ▲ or VOLUME ▼ will scroll between the menus.

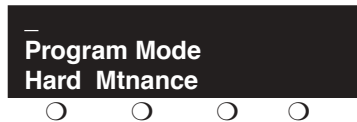

What the Soft Key Display Prompts Mean

When using a display phone in programming mode, you will see various Soft Key options displayed. These keys will allow you to easily select, scan, or move through the programs.

Soft key Display Prompts	
If you press this Soft Key . . .	The system will. . .
back	Go back one step in the program display. You can press VOLUME ▲ or VOLUME ▼ to scroll forwards or backwards through a list of Programs.
↑	Scroll down through the available programs.
↓	Scroll up through the available programs.
select	Select the currently displayed program.
←	Move the cursor to the left.
→	Move the cursor to the right.
-1	Move back through the available program options.
+1	Move forward through the available program options.

- For Your Notes -

3

Level: IN	Aspire S	Aspire M/L/XL
	• Available.	• Available.

Description

Use **Program 11-14 : Service Code Setup (for Hotel)** to customize the Service Codes which are used with the Hotel/Motel feature. You can customize additional Service Codes in Programs 11-10 through 11-13, 11-15 and 11-16. The Service Codes can only be used at telephones registered as hotel terminals in Program 42-02. The following chart shows:

- The number of each code (01-17)
- The function of the Service Code.
- What type of telephones can use the Service Code
- The code’s default entry.

If you change a Service Code, be sure to record your entry in the “New” column.

Input Data

Item No.	Item	Terminals	Default
01	Set DND for Own Extension	KTS, SLT	127
02	Cancel DND for Own Extension	KTS, SLT	128
03	Set DND for Other Extension	KTS, SLT	129
04	Cancel DND for Other Extension	KTS, SLT	130
05	Set Wake Up Call for Own Extension	KTS, SLT	131
06	Cancel Wake Up Call for Own Extension	KTS, SLT	132
07	Set Wake Up Call for Other Extension	KTS, SLT	133
08	Cancel Wake Up Call for Other Extension	KTS, SLT	134
09	Set Room-to-Room Call Restriction	KTS, SLT	135
10	Cancel Room-to-Room Call Restriction (Hotel)	KTS, SLT	136
11	Change Toll Restriction Class for Other Extension	KTS, SLT	137
12	Check-In	KTS, SLT	138
13	Check-Out	KTS, SLT	139
14	Room Status Change for Own Extension	KTS, SLT	140

Programming

11-14 : Service Code Setup (for Hotel)

Item No.	Item	Terminals	Default
15	Room Status Change for Other Extension	KTS, SLT	141
16	Room Status Output	KTS, SLT	142
17	Hotel Room Monitor	KTS, SLT	175
18	Hotel PMS Toll Restriction Set	KTS	166

Conditions

None

Feature Cross Reference

- Do Not Disturb
- Room Status
- Room Status Printouts
- Room-to-Room Call Restriction
- Wake Up Call
- Toll Restriction

Telephone Programming Instructions

To enter data for Program 11-14 (Service Code Setup (for Hotel)):

1. Enter the programming mode.
2. 11 14

```
11-14-01
DND Own-Ext.
back ↑ ↓ select
```

3. Enter the number of the item you want to program.

```
11-14-nn
nnnnn
← →
```

4. Enter data for the item you selected + HOLD.
5. Enter data for the next item in the program.
OR
Press MSG once to enter a new item number.
OR
Press MSG until you've exited that series's programming section.

Level: IN	Aspire S	Aspire M/L/XL
	• Available.	• Available.

Description

Use **Program 15-03 : Single Line Telephone Basic Data Setup** to set up various single line telephone options.

Input Data

Extension Number	Max. 8 digits
------------------	---------------

Item No.	Item	Input Data	Default	Related Program
13	MW Signal Type For analog single line telephones which provide a display, when a user leaves a Message Waiting for a SLT which has a display, this option is used to determine whether the SLT user will see a MW LED indication or if the Caller ID will be used to display the call.	0 = Lamp Indication 1 = Caller ID Indication	0	

3

Conditions

None

Feature Cross Reference

- Message Waiting

Telephone Programming Instructions

To enter data for Program 15-03 (Single Line Telephone Basic Data Setup):

1. Enter the programming mode.
2. 15 03



3. Enter the number of the item you want to program.



4. Select the telephone number to be programmed by pressing the FLASH or the VOLUME ▲ or VOLUME ▼ keys.
5. Enter data for the item you selected + HOLD.
6. Enter data for the next item in the program.
OR
Press MSG once to enter a new item number.
OR
Press MSG until you've exited that series's programming section.

Level:	Aspire S	Aspire M/L/XL
IN	• Available.	• Available.

Description

Use **Program 20-06 : Class of Service for Extensions** to assign a Class of Service to an extension. There are 15 Classes of Service that can be assigned. To specify the options in each Class of Service, refer to Programs 20-07 through 20-13. You make eight entries for Program 20-06, one for each Night Service Mode (Day, Night, Midnight, Rest, Day 2, Night 2, Midnight 2, Rest 2).

Input Data

Extension Number	Max. 8 digits
------------------	---------------

Item No.	Day/Night Mode	Class of Service for Extensions
01	Aspire S: 1-4 Aspire: 1-8	1-15



Default

- Extension number 301 is set as Class 15.
- All other extension numbers are set as Class 1.

Conditions

None

Feature Cross Reference

- Do Not Disturb
- Message Waiting
- Room Status
- Room Status Printouts
- Room-to-Room Call Restriction
- Toll Restriction (When Checked In)
- Wake Up Call

Telephone Programming Instructions

To enter data for Program 20-06 (Class of Service for Extensions):

1. Enter the programming mode.
2. 20 06

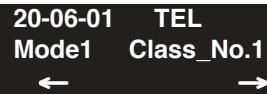

```
20-06-01 TEL
Mode1 Class_No.1
← →
```

3. Enter the number of the item you want to program.



```
20-06-nn TELnnn
nnnnn
← →
```

4. Select the telephone number to be programmed by pressing the FLASH or the VOLUME ▲ or VOLUME ▼ keys.
5. Enter data for the item you selected + HOLD.
6. Enter data for the next item in the program.
OR
Press MSG once to enter a new item number.
OR
Press MSG until you've exited that series's programming section.

Level:	Aspire S	Aspire M/L/XL
IN	• Available.	• Available.

Description

Use **Program 20-13 : Class of Service Options (Supplementary Service)** to define the supplementary feature availability for each extension’s Class of Service.

Input Data

Class of Service Number	01-15
-------------------------	-------

Item No.	Item	Input Data	Default	
			COS 01-14	COS 15
07	Message Waiting Turn off or on an extension’s ability to leave Message Waiting.	0 = Off 1 = On	1	1
40	Do Not Disturb This option will allow or prevent the user from being able to use the Do Not Disturb feature.	0 = Off 1 = On	1	1

3

Conditions

None

Feature Cross Reference

- Do Not Disturb
- Message Waiting

Telephone Programming Instructions

To enter data for Program 20-13 (Class of Service Options (Supplementary Service)):

1. Enter the programming mode.
2. 20 13

```
20-13-01 FCTN Cls1
Long_Conv.Alarm 1:On
back ↑ ↓ select
```

3. Enter the number of the item you want to program.

```
20-13-nn FCTN Clsnn
nnnnn
← →
```

4. Select the Class of Service number to be programmed by pressing the FLASH or the VOLUME ▲ or VOLUME ▼ keys.
5. Enter data for the item you selected + HOLD.
6. Enter data for the next item in the program.
OR
Press MSG once to enter a new item number.
OR
Press MSG until you've exited that series's programming section.

Level: IN	Aspire S	Aspire M/L/XL
	• Available.	• Available.

Description

Use Program **20-17 : Operator's Extension** to designate an operator. When an extension user dials "0" or "9" (defined by Program 11-01 Type 5), calls go to the operator selected in this program.

If you don't assign an extension in Program 90-11-01, system alarms appear on the extension assigned in this option.

Input Data

Operator Number	1-8
-----------------	-----

Item No.	Item	Input Data	Default	Related Program
01	Operator's Extension Number Define the extension numbers which are to be used as operators.	Up to 8 digits	301	11-01 20-01-01
02	Operator Console Mode Determine if the operator's keyset will act as a normal keyset (0) or if keys 13-24 will be used for Personal Park of outside calls (1). With this option, an operator may not need a DSS Console.	0 = Normal keyset 1 = Special Operator Console	0	

3

Conditions

None

Feature Cross Reference

- Intercom

Telephone Programming Instructions

To enter data for Program 20-17 (Operator's Extension):

1. Enter the programming mode.
2. 20 17

20-17-01 Operator1
Operator_No.
back ↑ ↓ select

3. Enter the number of the item you want to program.

20-17-nn Operatorn
nnnnn
← →

4. Select the operator number to be programmed by pressing the FLASH or the VOLUME ▲ or VOLUME ▼ keys.
5. Enter data for the item you selected + HOLD.
6. Enter data for the next item in the program.
OR
Press MSG once to enter a new item number.
OR
Press MSG until you've exited that series's programming section.

Level: IN	Aspire S	Aspire M/L/XL
	• Available.	• Available.

Description

Use **Program 21-04 : Toll Restriction Class** to assign a Toll Restriction class to an extension. The details of Toll Restriction are defined in Program 21-05 and 21-06.

Input Data

Extension Number	Max. 8 digits
------------------	---------------

Item No.	Day/Night Mode	Restriction Class	Default	Related Program
01	1-9 9: (power failure mode)	1-15	2	14-01-08 21-05



Conditions

None

Feature Cross Reference

- Toll Restriction

Telephone Programming Instructions

To enter data for Program 21-04 (Toll Restriction Class for Extensions):

1. Enter the programming mode.
2. 21 04

```
21-04-01 TEL
Mode1 =T/R_Class 2
back ↑ ↓ select
```

3. Enter the number of the item you want to program.

```
21-04-nn TELnnn
nnnnn
← →
```

4. Select the telephone number to be programmed by pressing the FLASH or the VOLUME ▲ or VOLUME ▼ keys.
5. Enter data for the item you selected + HOLD.
6. Enter data for the next item in the program.
OR
Press MSG once to enter a new item number.
OR
Press MSG until you've exited that series's programming section.

Level: IN	Aspire S	Aspire M/L/XL
	• Available.	• Available.

Description

Use **Program 21-05 : Toll Restriction Class** to set the system’s Toll Restriction classes (1-15).

Input Data

Toll Restriction Class Number	1-15
-------------------------------	------

Item No.	Item	Input Data	Description	Related Program
01	International call restriction table	0 = Unassigned 1 = Assigned	This option assigns/unassigns the International Call Restrict Table for the Toll Restriction Class you are programming. Enter International Call Restrict Table data in Program 21-06-01.	21-06-01
02	International call permit code table	0 = Unassigned 1 = Assigned	This option assigns/unassigns the International Call Permit Table for the Toll Restriction Class you are programming. Enter International Call Permit Table data in Program 21-06-02.	21-06-02
03	Not Used			
04	Maximum Number of Digits Table Assignment	1-4 = Table 0 = Disable	Select the table (defined in 21-06-03) to be used to determine the maximum number of digits allowed for outgoing calls.	21-06-03
05	Common permit code table	0 = Unassigned 1 = Assigned	It chooses whether the table set up by 21-06-04 is referred to, or not referred to.	21-06-04
06	Common restriction table	0 = Unassigned 1 = Assigned	It chooses whether the table set up by 21-06-05 is referred to, or not referred to.	21-06-05
07	Permit code table	1-4 = Table 0 = Disable	Set the tables 1-4 when referring to the table set up by 21-06-06.	21-06-06
08	Restriction table	1-4 = Table 0 = Disable	Set the tables 1-4 when referring to the table set up by 21-06-07.	21-06-07
09	Restriction for common abbreviated dials	0 = Does not restrict 1 = Following restriction check	Use this option to enable/disable Toll Restriction for Common Abbreviated Dialing numbers. If enabled, Common Abbreviated Dialing numbers have the same restrictions as manually dialed numbers.	
10	Restriction for group abbreviated dials	0 = Does not restrict 1 = Following restriction check	Use this option to enable/disable Toll Restriction for Group Abbreviated Dialing numbers. If enabled, Group Abbreviated Dialing numbers have the same restrictions as manually dialed numbers.	

Programming

21-05 : Toll Restriction Class

3

Item No.	Item	Input Data	Description	Related Program
11	Intercom Call Restriction	0 = Disable 1 = Enable	This option determines whether an ICM incoming call is restricted.	
12	PBX Call Restriction	0 = Disable 1 = Enable	Use this option to set how the system Toll Restricts calls over PBX trunks. If you enable PBX Toll Restriction, the system begins Toll Restriction after the PBX access code. The user cannot dial a PBX extension. If you disable PBX Toll Restriction, the system only restricts calls that contain the PBX access code. The system does not restrict calls to PBX extensions. Refer to the PBX compatibility feature. Make sure Program 21-05-04 (Maximum Number of Digits Table Assignment) allows for PBX Toll Call Dialing (normally 12 digits).	
13	Restriction of Tie Line Calls	0 = Disable 1 = Enable	It chooses whether the toll restriction of the dial set up by 34-08 is enabled or disabled.	34-08
14	Restrict Trunk Transfer for Incomplete Dial	---	- Not Used in U.S. -	
15	Restrict Common Hold for Incomplete Dial	---	- Not Used in U.S. -	

Default

	Item No														
	1	2	3	4	5	6	7	8	9	10	11	12	13	14	15
Class No. 1	0	0	0	0	0	0	0	0	0	0	0	0	0	0	0
Class No. 2	0	0	0	0	1	1	0	0	0	0	0	0	0	0	0
Class No. 3	1	1	0	0	1	1	0	0	0	0	0	0	0	0	0
Class No. 4	1	1	1	0	1	1	0	0	0	0	0	0	0	0	0
Class No. 5	1	1	1	0	1	1	0	0	1	0	0	0	0	0	0
Class No. 6	1	1	1	0	1	1	0	0	1	1	0	0	0	0	0
Class No. 7	1	1	1	0	1	1	0	0	1	1	1	0	0	0	0
Class No. 8	1	1	1	1	1	1	1	1	1	1	1	1	0	0	0
:	:	:	:	:	:	:	:	:	:	:	:	:	:	0	0
Class No. 15	1	1	1	1	1	1	1	1	1	1	1	1	0	0	0

Conditions

None

Feature Cross Reference

- Toll Restriction

Telephone Programming Instructions

To enter data for Program 21-05 (Toll Restriction Class):

1. Enter the programming mode.
2. 21 05

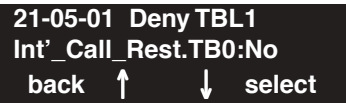

3. Enter the number of the item you want to program.

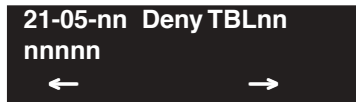

4. Select the Deny Table number to be programmed by pressing the FLASH or the VOLUME ▲ or VOLUME ▼ keys.
5. Enter data for the item you selected + HOLD.
6. Enter data for the next item in the program.
OR
Press MSG once to enter a new item number.
OR
Press MSG until you've exited that series's programming section.

Programming

21-06 : Toll Restriction Table Data Setup

Level: IN	Aspire S	Aspire M/L/XL
	• Available.	• Available.

Description

Use **Program 21-06 : Toll Restriction Table Data Setup** to set the system's Toll Restriction data. Dial 1-9, 0, *, # can be entered in each table.

Input Data

Item No.	Item	Table	Input Data	Default
01	International Call Restriction Table This option lets you program the Restrict Table for international calls. The system has 10 International Call Restrict Tables. Each entry can be up to four digits long.	1-10	Dial (Up to 4 digits)	Table 1-10 = No Setting
02	International Call Permit Code Table This option lets you program the Permit Table for international calls. The system has 20 International Call Permit Table. Each entry can be up to six digits long, using.	1-20	Dial (Up to 6 digits)	No Setting
03	Maximum Number Digits Table Assignment This option selects the maximum number of digits allowed in outgoing calls for each table.	1-4	4-30	Tables 1 - 4 = 30
04	Common Permit Code Table This option lets you program the Common Permit Code Table. This table contains up to 10 codes you commonly allow users to dial.	1-10	Dial (Up to 4 digits)	Table 1 = 911 Table 2 = 1800 Table 3 = 1888 Table 4 = 1822 Table 5 = 1833 Table 6 = 1844 Table 7 = 1855 Table 8 = 1866 Table 9 = 1877 Table 10 = No Setting
05	Common Restriction Table This option lets you program the Common Restrict Code Table. This table contains up to 10 codes you commonly prevent users from dialing.	1-10	Dial (Up to 12 digits)	Table 1 = 900 Table 2 = 1900 Table 3 = 976 Tables 4 = 10 = No Setting
06	Permit Code Table This option lets you program the Permit Code Tables. If the system has Toll Restriction enabled, users can dial numbers only if permitted by these tables and the Common Permit Table (21-06-04). There are four Permit Code Tables, with up to 200 entries in each table. The system permits calls exactly as you enter the code.	1-4 (table) 1-60 (Entry)	Dial (Up to 12 digits)	Table 1 - 4 = No Setting

Item No.	Item	Table	Input Data	Default
07	<p>Restriction Table This option lets you program the Restrict Code Tables. If the system has Toll Restriction enabled, users cannot dial numbers listed in these tables. There are four Restrict Code Tables, with up to 200 entries in each table. The system restricts calls exactly as you enter the code.</p>	1-4 (table) 1-60 (Entry)	Dial (Up to 12 digits)	Table 1 - 4 = No Setting
08	<p>PBX Access Code Use this option to enter the PBX Access Code. When the system is behind a PBX, this is the code users dial to access a PBX trunk. Toll Restriction begins after the PBX access code. For PBX trunks (Program 14-04) the system only Toll Restricts calls that contain the access code. Always program this option when the system is behind a PBX, even if you don't want to use Toll Restriction. PBX Access Codes can be up to 2 digits, using 0-9, #, * and LINE KEY 1 (don't care). When using Account Codes, do not use an asterisk within a PBX access code. Otherwise, after the *, the trunk would stop sending digits to the central office. Entries 1-4 correspond to the 4 PBX Access Codes. Each code can have up to 2 digits.</p>	1-4	Dial (Up to 2 digits)	Table 1 - 4 = No Setting
09	<p>Specific Dial Outgoing Code <i><u>This option is not currently used</u></i> This option can be used to exempt digits from toll restriction. The digits entered in this option will bypass the toll restriction programming. The digits to be exempt can be positioned before or after the entry in Program 21-06-10.</p>	1-20	Dial (Up to 8 digits)	No Setting
10	<p>Outgoing Call Code Setup <i><u>This option is not currently used</u></i> This option can be used to exempt digits from toll restriction. The digits entered in this option will bypass the toll restriction programming. This is similar to Program 21-06-09, however, these digits must be first. For example, if a system restricts international dialing (011), it could be possible to allow the system to dial 1010XXX + 011 or *67 + 011. In order to dial *67 + 1010XXX + 011, *67 would be entered in Program 21-06-10 and 1010XXX would be entered in Program 21-06-09.</p>	1-20	Dial (Up to 4 digits)	No Setting

Conditions

None

Feature Cross Reference

- Toll Restriction

Telephone Programming Instructions

To enter data for Program 21-06 (Toll Restriction Table Data Setup):

1. Enter the programming mode.
2. 21 06

21-06-01 Int'l TBL 1
IDD_Dial_Rest.TB 001
back ↑ ↓ select

3. Enter the number of the item you want to program.

21-06-nn Int'l TBL nn
nnnnn
← →

4. Select the International Table number to be programmed by pressing the FLASH or the VOLUME ▲ or VOLUME ▼ keys.
5. Enter data for the item you selected + HOLD.
6. Enter data for the next item in the program.
OR
Press MSG once to enter a new item number.
OR
Press MSG until you've exited that series's programming section.

Level:	Aspire S	Aspire M/L/XL
IN	• Available.	• Available.

Description

Use **Program 30-01 : DSS Console Operating Mode** to set the mode of the system’s DSS Consoles. The entry you make in this option applies to all the system’s DSS Consoles. The available options are:

- Regular (Business) Mode (0)
This option indicates the status of normal keysets (not ACD agents).
- Hotel Mode (1)
With this option, each console’s keys are redefined as follows:

This key in	Has this function in
<u>Business Mode</u>	<u>Hotel/Motel Mode</u>
PAGE	MESSAGE (Message Waiting)
GROUP	WAKE UP (Wake Up Calls)
DOOR	STATUS (Room Status)
- ACD Monitor Mode (2)
This option indicates the status of ACD agents (non-ACD agents are not included).
- Business/ACD Monitor Mode (3)
This option allows a non-ACD DSS console to lamp indicating the status of both non-ACD agents as well as ACD agents.



Input Data

DSS Console Number	Aspire S: 1-4 Aspire: 01-32
--------------------	--------------------------------

Item No.	DSS Operation Mode	Default
01	0 = Business mode 1 = Hotel mode 2 = ACD monitor mode (Aspire M/L/XL only) 3 = Business/ACD mode (Aspire M/L/XL only)	0

Conditions

None

Feature Cross Reference

- DSS Console Monitoring

Telephone Programming Instructions

To enter data for Program 30-01 (DSS Console Operating Mode):

1. Enter the programming mode.
2. 30 01



```
30-01-01
Operation_Mode0:Business
back  ↑  ↓  select
```

3. Enter the number of the item you want to program.



```
30-01-nn
nnnnn
←      →
```

4. Enter data for the item you selected + HOLD.
5. Enter data for the next item in the program.
OR
Press MSG once to enter a new item number.
OR
Press MSG until you've exited that series's programming section.

Level: IN	Aspire S	Aspire M/L/XL
	• Available.	• Available.

Description

Use **Program 30-02 : DSS Console Extension Assignment** to identify which extensions have DSS Consoles connected.

- **Aspire S:**
You can have up to 4 different extensions with DSS Consoles. A single extension can have up to 4 110-Button DSS Consoles.
- **Aspire:**
You can have up to 32 different extensions with DSS Consoles. A single extension can have up to 4 110-Button DSS Consoles (32 is the maximum allowed per system).
- Each extension in the system can have one 24-Button DLS Console (Aspire S: 24 maximum, Aspire: 256 maximum). An extension can have a 24-Button DLS Console in addition to 110-Button DSS Consoles.

When programming, each extension/DSS Console(s) combination is called a Console Number. There are 32 Console Numbers (1-32). You assign Console Numbers to extensions. When entering data, you normally make the assignment for Console Number 1 first.

Input Data

110-Button DSS Console Number	Aspire S: 1-4 Aspire: 01-32
-------------------------------	--------------------------------

Item No.	Description	Default
01	The extension number for Key Telephone connected with the DSS console (Up to 8 digits)	No setting

Conditions

24-button DSS consoles cannot be daisy-chained.

Feature Cross Reference

- Direct Station Selection (DSS) Console

Telephone Programming Instructions

To enter data for Program 30-02 (DSS Console Extension Assignment):

1. Enter the programming mode.
2. 30 02

```
30-02-01 DSS1
Ext.Number
back ↑ ↓ select
```

3. Enter the number of the item you want to program.

```
30-02-nn DSSnn
nnnnn
← →
```

4. Select the DSS number to be programmed by pressing the FLASH or the VOLUME ▲ or VOLUME ▼ keys.
5. Enter data for the item you selected + HOLD.
6. Enter data for the next item in the program.
OR
Press MSG once to enter a new item number.
OR
Press MSG until you've exited that series's programming section.

3

Level: IN	Aspire S	Aspire M/L/XL
	• Available.	• Available.

Description

Use Program **42-01 : System Options for Hotel/Motel** to assign the system options for Hotel/Motel Service.

Input Data

Item No.	Item	Input Data	Default
01	Answering Message Mode for Wake Up Call (Hotel Mode) Use this option to determine what a guest hears when they answer a Wake Up call. The options are Music on Hold, VRS message, or a VRS message and time.	0 = MOH 1 = VRS Message (specified in 42-01-02) 2 = VRS Message (specified in 42-01-02) + Time	0
02	Wake Up Call Message Assignment VRS Message for Wake Up Calls. You'll need to make an entry for this program if you have selected option 1 or 2 in Item 1 above.	0-48 (0 = No setting)	0
03	Wake Up Call No Answer If enabled (1), unanswered Wake Up Calls will automatically ring the operator. If disabled (0), unanswered Wake Up Calls will not ring the operator.	0 = No transfer 1 = Transfer to the Operator	0
04	Setup Message Mode for Wake Up Call (Hotel Mode) Determine what the user will hear after setting a Wake Up message.	0 = Only Confirmation Tone 1 = VRS Message 2 = Time Information and VRS	0
05	Wake Up Call Message Assignment Assign the VRS Message heard after programming Wake Up Calls. You need to program this option only if you have enabled mode 1 or 2 in Program 42-01-04 above.	0-48 = VRS Message Number	-

Conditions

None

Feature Cross Reference

- Wake Up Call

Telephone Programming Instructions

To enter data for Program 42-01 (System Options for Hotel/Motel):

1. Enter the programming mode.
2. 42 01

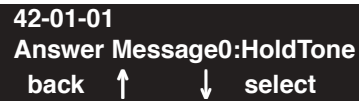

42-01-01
Answer Message0:HoldTone
back ↑ ↓ select

3. Enter the number of the item you want to program.



42-01-nn
nnnnn
← →

4. Enter data for the item you selected + HOLD.
5. Enter data for the next item in the program.
OR
Press MSG once to enter a new item number.
OR
Press MSG until you've exited that series's programming section.

Level: IN	Aspire S	Aspire M/L/XL
	• Available.	• Available.

Description

Use **Program 42-02 : Hotel/Motel Telephone Setup** to define the basic operation of the Hotel/Motel extensions.

Input Data

Extension Number	Up to 8 digits
------------------	----------------

Item No.	Item	Input Data	Default
01	Hotel Mode If you want an extension to operate in the Hotel/Motel mode, 1. If you want the telephone to operate in the business mode, enter 0. (This will exclude the telephone from the Hotel/Motel features covered in this guide.)	0 = Normal 1 = Hotel	0
02	Toll Restriction Class When Check In Assign an extension's Toll Restriction Class when it is checked in. The system has 15 Toll Restriction Classes (1-15). The entry you make in this option affects the telephone in all Night Service modes. (Refer to Programs 21-05 and 21-06 to set up the Toll Restriction dialing options.) When the extension is checked out, it uses the Toll Restriction Class set in Program 21-04.	1-15	1

3

Conditions

None

Feature Cross Reference

- Hotel/Motel
- Toll Restriction (When Checked In)

Telephone Programming Instructions

To enter data for Program 42-02 (Hotel/Motel Telephone Setup):

1. Enter the programming mode.
2. 42 02

42-02-01 TEL
Hotel Mode 0:Normal
back ↑ ↓ select

3. Enter the number of the item you want to program.

42-02-nn TELnnn
nnnnn
← →

4. Select the telephone number to be programmed by pressing the FLASH or the VOLUME ▲ or VOLUME ▼ keys.
5. Enter data for the item you selected + HOLD.
6. Enter data for the next item in the program.
OR
Press MSG once to enter a new item number.
OR
Press MSG until you've exited that series's programming section.

3

Level: IN	Aspire S	Aspire M/L/XL
	• Available.	• Available.

Description

Use **Program 42-03 : Class of Service Options (Hotel)** to set the Hotel/Motel Class of Service (COS) options. Assign Class of Service to extensions in **Program 42-02 : Hotel/Motel Telephone Setup**. There are 15 Classes of Service. Refer to the following chart for a description of each COS option, its range and default setting. For additional Class of Service options, refer to Programs 20-06 - 20-14.

Input Data

Class of Service Number	01-15
-------------------------	-------

Item No.	Item	Input Data	Default	
			Class 01	Class 02-15
01	Check-In Operation Enable or disable an extension's ability to set the Check In status of an extension.	0 = Disable 1 = Enable	0	0
02	Check-Out Operation Enable or disable an extension's ability to set the Check Out status of an extension.	0 = Disable 1 = Enable	0	0
03	Room Status Output Enable or disable an extension's ability to request Room Status Printouts.	0 = Disable 1 = Enable	0	0
04	DND Setting for Other Extension Enable or disable an extension's ability to Hotel DND for another extension.	0 = Disable 1 = Enable	0	0
05	Wake Up Call Setting for Other Extension Enable or disable an extension's ability to set a Wake Up Call for another extension.	0 = Disable 1 = Enable	0	0
06	Room Status Change for Other Extension Enable or disable an extension's ability to change the house cleaning status of another room.	0 = Disable 1 = Enable	0	0
07	Restriction Class Changing for Other Extension Enable or disable an extension's ability to set the Toll Restriction Level (When Checked In) for another extension.	0 = Disable 1 = Enable	0	0
08	Room-to-Room Call Restriction Enable or disable an extension's ability to set Room-to-Room Call Restriction for another extension.	0 = Disable 1 = Enable	0	0

Item No.	Item	Input Data	Default	
			Class 01	Class 02-15
09	DND Setting for Own Extension Enable or disable an extension's ability to set Hotel DND for itself.	0 = Disable 1 = Enable	0	0
10	Wake Up Call Setting for Own Extension Enable or disable an extension's ability to set a Wake Up Call for itself.	0 = Disable 1 = Enable	0	0
11	Room Status Change for Own Extension Enable or disable an extension's ability to change the house cleaning status of their own room.	0 = Disable 1 = Enable	0	0
12	SLT Room Monitor Enable (1) or disable (0) a single line telephone's ability to use Room Monitor.	0 = Disable 1 = Enable	0	0
13	PMS Restriction Level - Not Currently Used -	0 = Disable 1 = Enable	0	0

Conditions

None

Feature Cross Reference

- Do Not Disturb
- Room Status
- Room Status Printouts
- Room-to-Room Call Restriction
- Toll Restriction (When Checked In)
- Wake Up Call

Telephone Programming Instructions

To enter data for Program 42-03 (Class of Service Options (Hotel/Motel)):

1. Enter the programming mode.
2. 42 03

```
42-03-01 FCTN Cls1
Check-in      1:On
back  ↑      ↓  select
```

3. Enter the number of the item you want to program.

```
42-03-nn FCTN Clsnn
nnnnn
←          →
```

4. Select the Class of Service number to be programmed by pressing the FLASH or the VOLUME ▲ or VOLUME ▼ keys.
5. Enter data for the item you selected + HOLD.
6. Enter data for the next item in the program.
OR
Press MSG once to enter a new item number.
OR
Press MSG until you've exited that series's programming section.

Programming

42-04 : Hotel Mode One-Digit Service Codes



Level: IN	Aspire S	Aspire M/L/XL
	• Available.	• Available.

Description

Use **Program 42-04 : Hotel Mode One-Digit Service Codes** to set up the Hotel Mode one-digit service code. For each Department Group (1-8 or 1-64) you enter the destination for each single digit code (1-9, 0, *, #). The destination can be any code up to four digits long, such as an extension number or access code. These codes can be used by the extensions assigned to Hotel Mode in 42-02-01.

Input Data

Department (Extension) Group Number	Aspire S: 1-8 Aspire: 01-64
-------------------------------------	--------------------------------

Item No.	Received Dial	Destination Number	Default
01	1-9,0,*,#	Up to 8 digits	No setting

Conditions

The one-digit codes you assign in this program wait until the Interdigit timer expires before executing.

Feature Cross Reference

- Single Digit Dialing

3

Telephone Programming Instructions

To enter data for Program 42-04 (Hotel Mode One-Digit Service Codes):

1. Enter the programming mode.
2. 42 04

```
42-04-01 TEL Group1
1digit Accs 1=
back ↑ ↓ select
```

3. Enter the number of the item you want to program.

```
42-04-nn TEL Groupnn
nnnnn
← →
```

4. Select the Department/Telephone Group number to be programmed by pressing the FLASH or the VOLUME ▲ or VOLUME ▼ keys.
5. Enter data for the item you selected + HOLD.
6. Enter data for the next item in the program.
OR
Press MSG once to enter a new item number.
OR
Press MSG until you've exited that series's programming section.

Programming

42-05 : Hotel Room Status Printer



Level: IN	Aspire S	Aspire M/L/XL
	• Available.	• Available.

Description

Use **Program 42-05 : Hotel Room Status Printer** to set the CTA port to output the Hotel Data (Check-Out sheet, Room Status etc...) and the output options for the Hotel/Motel feature.

Input Data

Item No.	Item	Input Data	Default
01	Output Port Type If a Hotel Room Status Printer is to be used, enter "1".	0 = No setting 1 = CTA	0
02	Output Destination Number Enter the CTA extension number to which the Hotel Room Status Printer is connected.	Up to 8 digit (Extension number which CTA/CTU is equipped.)	No setting
03	Wake Up Call No Answer Data Enable or disable the ability to have unanswered Wake Up Calls automatically print on the Room Status Printer.	0 = No output 1 = Output Unanswered Wake Up Calls	0
04	Check-Out Sheet Enable or disable the ability to have the Room Status Printer automatically print when a room Checks Out.	0 = No output 1 = Output Room Check Out	0

Conditions

Room Status Reports require a CTA and a compatible printer. Refer to Data Communications in the Aspire Software Manual (P/N 0893200) for information.

Feature Cross Reference

- Room Status Printouts



Telephone Programming Instructions

To enter data for Program 42-05 (Hotel Room Status Printer):

1. Enter the programming mode.
2. 42 05



42-05-01
Output Port Type 0:No
back ↑ ↓ select

3. Enter the number of the item you want to program.



42-05-nn
nnnnn
← →

4. Enter data for the item you selected + HOLD.
5. Enter data for the next item in the program.
OR
Press MSG once to enter a new item number.
OR
Press MSG until you've exited that series's programming section.

Programming

90-11 : System Alarm Report

Level: IN	Aspire S	Aspire M/L/XL
	• Available.	• Available.

Description

Use **Program 90-11 : System Alarm Report** to define the details of the system alarm report.

Input Data

Item No.	Item	Input Data	Default
01	System Alarm Display Telephone Assign the display keyset extension number that should receive system alarms.	Extension Number (Up to 8 digits)	No setting
02	Report Method When alarm reports are to be EMailled, set this option to "1".	0 = No report 1 = EMail Address	0
04	- Not Used -	-	0
06	SMTP Host Name When alarm reports are to be EMailled, set the SMTP name (ex: smtp.yourisp.com) or IP address. Contact your ISP (internet service provider) for the correct entry if needed.	Up to 255 Characters	No setting
07	SMTP Host Port Number When alarm reports are to be EMailled, set the SMTP host port number. Contact your ISP (internet service provider) for the correct entry if needed.	0-65535	25
08	To EMail Address When alarm reports are to be EMailled, set this EMail address to which the report should be sent.	Up to 255 Characters	No setting
09	Reply Address When alarm reports are to be EMailled, set this EMail address to which any replies should be EMailled.	Up to 255 Characters	No setting
10	From Address When alarm reports are to be EMailled, set this EMail address from which the report is being sent. This entry is required for EMail-ing alarms.	Up to 255 Characters	No setting
11	DNS Primary Address When alarm reports are to be EMailled, set the DNS primary address.	0.0.0.0-255.255.255.255	0.0.0.0

3

12	DNS Secondary Address When alarm reports are to be Emailed, set the DNS secondary address.	0.0.0.0-255.255.255.255	0.0.0.0
13	Customer Name When alarm reports are to be Emailed, enter a name which will be used to identify the particular system.	Up to 255 Characters	No setting

Conditions

None

Feature Cross Reference

None

Telephone Programming Instructions

3

To enter data for Program 90-11 (System Alarm Setup):

1. Enter the programming mode.
2. 90 11



3. Enter the number of the item you want to program.



4. Enter data for the item you selected + HOLD.
5. Enter data for the next item in the program.
OR
Press MSG once to enter a new item number.
OR
Press MSG until you've exited that series's programming section.

- For Your Notes -

3

Section 4

Setting Up Flexible System Numbering

4

- For Your Notes -

4

When to Use Flexible System Numbering

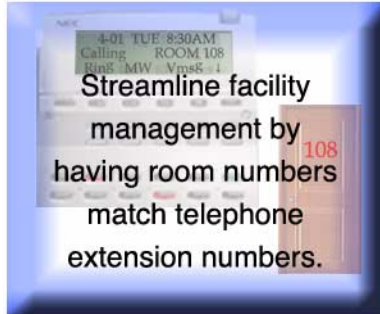

Flexible System Numbering lets you match telephone extension numbers to room numbers. This simplifies room-to-room calling and record keeping. For example, rooms 101-110 on the first floor can have extension numbers 101-110. Rooms 201-210 on the second floor can have extension numbers 201-210. In addition, the SMDR phone records for each telephone will correspond to the room numbers making guest billing easier.

!! Be Careful !!

If your room numbers are not within the normal extension number plan range (i.e., 301-556), you may have to restructure your system numbering. Be very careful when changing your system numbering and document all the changes you make.

Before changing your numbering plan, make a backup copy of your system's data. Use PCPro and download and save the customer database. Or, you can use Program 90-03 and a PC-ATA card or CompactFlash with PCMCIA Adapter to save the database.

4

For your convenience, a table showing the default numbering plan begins on page 4-4.

Flexible System Numbering Introduction



System Number Plan/Capacities

System Number Plan/Capacities			
System Type:	Aspire S	Aspire M/L	Aspire XL
System			
Analog Caller ID Detector	24	64	64
Classes of Service	15	15	15
Day/Night Mode Numbers	4	8	8
Day/Night Service Patterns	4	32	32
Dial Tone Detector DTMF Receiver	16	64	64
System Ports (trunks and analog/digital extensions)	8 trunks and 50 extensions	<ul style="list-style-type: none"> • NTCPU with Basic PAL = 64 trunks/extensions • NTCPU with Feature Upgrade PAL = 128 trunks/extensions • NTCPU-B 200 trunks and 256 extensions 	<ul style="list-style-type: none"> • 200 trunks and 384 extensions
Toll Restriction Classes	15	15	15
Verifiable Account Code Table	2000	2000	2000
Trunk			
Trunk Port Number	1-8	1-200 ¹	1-200
	¹ With the basic NTCPU (P/N 0891002), trunks count toward the total number of allowed hardware ports (64 or 128 ports depending on the PAL EPROM and software installed)		
Trunk Ports (Total)	8	200	200
• Analog Trunks	8	200	200
• BRI Trunk Ports	4 (8B)	96 (192B)	96 (192B)
• T1/PRI Trunk Ports	N/A	192	192
• E&M Analog Trunk Ports	N/A	60	60
• DID Analog Trunk Ports	8	120	120
• VoIP Trunk Ports	8	200	200
BRIU Logical Ports	T-Bus: 1-8 S-Bus: 1-26	T-Bus: 1-200 S-Bus: 1-256	T-Bus: 1-200 S-Bus: 1-256
COIU:			
• Physical Ports	01-04	01-08	01-08
• Logical Ports	0-8	0-200	0-200

System Number Plan/Capacities			
System Type:	Aspire S	Aspire M/L	Aspire XL
DIOPU: <ul style="list-style-type: none"> • Physical Ports • Logical Ports 	01-02 LD Trunk: 0-8 OPX: 0-8	01-08 LD Trunk: 0-200 OPX: 0-25	01-08 LD Trunk: 0-200 OPX: 0-25
PRIU Logical Ports	N/A	T-Bus: 1-200 S-Bus: 1-256	T-Bus: 1-200 S-Bus: 1-256
TLIU: <ul style="list-style-type: none"> • Physical Ports • Logical Ports 	N/A	01-08 0-200	01-08 0-200
VOIPU: <ul style="list-style-type: none"> • Physical Ports • Logical Ports 	1-8 0-8	01-32 0-200	01-32 0-200
DID Translation Tables	20	20	20
DID Translation Table Entries	2000	2000	2000
DISA <ul style="list-style-type: none"> • Classes of Service • Users 	15 1-15	15 1-15	15 1-15
Ring Groups	1-8	1-100	1-100
Tie Line Classes of Service	N/A	15	15
Tie Line Toll Restriction Classes	N/A	15	15
Trunk Access Maps	1-8	1-200	1-200
Trunk Group Numbers	1-8	1-100	1-100
Trunk Routes	1-8	1-100	1-100

Flexible System Numbering Introduction



4

System Number Plan/Capacities			
System Type:	Aspire S	Aspire M/L	Aspire XL
Extension			
Telephone Extension Port Numbers <ul style="list-style-type: none"> • Keysets • Single Line Phones/Analog Devices • VoIP Extensions • Aspire Wireless 	1-50 ³ (1-24) (1-18) (1-16) ^{2,4} N/A	1-256 (1-256) ² (1-256) ² (1-512) ⁵ 002-512 (manual select) ⁵ 257-512 (auto select) ⁵	1-384 (1-384) (1-384) (1-512) ⁵ 002-512 (manual select) ⁵ 385-512 (auto select) ⁵
<p>² Counts toward total number of allowed hardware ports (Aspire S=50 ports, Aspire M 64-Port NTCPU=64, Aspire M/L 64-Port NTCPU w/Feature Upgrade PAL=128, Aspire M/L w/Enhanced NTCPU=256, Aspire XL=384).</p> <p>³ The total number of ports available is determined by system software. Software provides 50 ports (Maximum Wired Terminals: 26 Includes keysets, single line telephones, ISDN terminals (APRs NOT included), Maximum IP Terminals: 16 Includes DtermIP and H.323 terminals, Maximum Special Terminals: Reserved for IntraMail: 8 (fixed extension ports 43-50)).</p> <p>⁴ If the APR-B2 mode is assigned in a system which already has 26 extensions, the number of IP phones is reduced.</p> <p>⁵ With the basic NTCPU (P/N 0891002), VoIP and Aspire Wireless extensions count toward the total number of allowed hardware ports (64 or 128 ports depending on the PAL EPROM and software installed). With the Enhanced NTCPU (P/N 0891038), if the number of VoIP and Aspire Wireless phones combined exceeds 256, the number of ports available for keysets or analog devices is then reduced by for each additional IP or Aspire Wireless phone.</p>			
ESIU <ul style="list-style-type: none"> • Physical Ports • Logical Ports <ul style="list-style-type: none"> -Tone Ringer (2PGDAD) -Door Box (2PGDAD) -Analog I/F (2PGDAD) -ACI (2PGDAD) -APR for B2 Mode 	1-8 1-4 1-4 1-8 1-8 1-42 (descending order)	01-16 1-8 1-8 1-96 1-96 193-512 (descending order)	01-32 1-8 1-8 1-96 1-96 193-512 (descending order)
SLIU <ul style="list-style-type: none"> • Physical Ports • Logical Ports 	1-8 1-26	01-16 1-256	01-16 1-384
Telephone Extension Number Range	301-499 5000-5312	301-499 5000-5312	301-499 5000-5312
Virtual Extension Ports	24	256	256
Virtual Extension Port Numbers	01-24	001-256	001-256
Virtual Extension Number Range	Undefined	Undefined	Undefined

System Number Plan/Capacities			
System Type:	Aspire S	Aspire M/L	Aspire XL
2PGDAD Modules	10	56	56
ADA (Recording Jack) Adapters	24	192	192
Aspire Wireless Bases	N/A	12	12
Aspire Wireless Phones	N/A	120	120
Door Boxes	4	8	8
Door Box Numbers	1-4	1-8	1-8
DSS Consoles Numbers	8	8	8
• 24-Button DLS Consoles, Maximum Installed	24	256	384
• 110-Button DSS Consoles, Maximum Installed	4	32	32
Handsfree Adapter (HF-R)	24	192	192
Operator Access Number	0	0	0
Operator Extension	1	1	1
Ringdown Assignments	512	512	512
SLT Adapters	8	16	16
Voice Mail Master Numbers	301-499, 5000-5312	301-499, 5000-5312	301-499, 5000-5312
Abbreviated Dialing			
Abbreviated Dialing Groups	8	64	64
Abbreviated Dialing Bins	0-1999	0-1999	0-1999
Abbreviated Dialing Table-Common	1000	1000	1000
ACD			
ACD Groups	N/A	64	64
ACD Agent Extensions	N/A	512	512
ACI			
ACI Groups	4	16	16
ACI Ports	8	96	96
Automated Attendant			
VRS Message Numbers	1-48	1-48	1-48
Conference			
Conference Circuits	32 - maximum (32 Parties Per Conference)	64 - maximum (32 Parties Per Conference)	64 - maximum (32 Parties Per Conference)

Flexible System Numbering Introduction



4

System Number Plan/Capacities			
System Type:	Aspire S	Aspire M/L	Aspire XL
Data Communication Interfaces			
APR Software Port Numbers	193-512	193-512	193-512
APA Adapters	24	192	192
APR Adapters	B1 = 24 B2 = 8 prior to 2.50 or 16 with 2.50+	192	192
CTA or CTU Adapters	24	128	128
Module Extension Number Range	301-499, 5000-5312	301-499, 5000-5312	301-499, 5000-5312
Department and Pickup Groups			
Department (Extension) Group Numbers	1-8	1-64	1-64
Department (Extension) Group Number Range	301-499, 5000-5312	301-499, 5000-5312	301-499, 5000-5312
Call Pickup Group Numbers	1-8	1-64	1-64
Hotline			
Internal Hotline	512	512	512
External Hotline	512	512	512
Paging and Park			
Internal Page Group Numbers	0, 1-8	0, 1-9 or 01-64	0, 1-9 or 01-64
External Page Group Numbers	0, 1-8	0, 1-8	0, 1-8
External Speakers	8	9	9
• NTCPU	N/A	(1)	(1)
• PGDAD Module	(1-8)	(1-8)	(1-8)
Park Group Numbers	1-64	1-64	1-64
Park Orbits	1-64	1-64	1-64
SMDR			
SMDR Ports	1-2	1-8	1-8
VRS			
VRS (on DSP Daughter Board)	1	1	1
VRS Channels	8	16	16
VRS Attendant Messages	3	3	3
VRS Recordable Messages	48	48	48

System Number Plan/Capacities			
System Type:	Aspire S	Aspire M/L	Aspire XL
Voice Mail			
Ports for IntraMail	8 (fixed extension ports 43-50)	N/A	N/A
Ports for External Voice Mail	72 ⁶	72	72
	⁶ Though this is the maximum available in the NVM-Series voice mail, as each voice mail port requires an analog port, the total number is restricted by the Aspire S system to a maximum of 16.		
VoIP			
VoIP Extensions	16 ⁴	<ul style="list-style-type: none"> • <i>NTCPU with Feature Upgrade PAL</i> = 128 • <i>NTCPU-B</i> = 512 	512
	⁴ If the APR-B2 mode is assigned in a system which already has 26 extensions, the number of IP phones is reduced.		
ADA2 (Recording Jack) Adapters	16	192	192
IP Adapters	16	256	256
IP Phones	16	512	512
PSA (Power Failure) Adapters	16	192	192
RAS Unicast Ports	0-65535	0-65535	0-65535
Call Signaling Ports	0-65535	0-65535	0-65535
NGT Signal Receive Ports	0-65535	0-65535	0-65535
DRS Ports	0-65535	0-65535	0-65535
RTP Ports	0-65535	0-65535	0-65535
RTCP Ports	0-65535	0-65535	0-65535
H.245 Ports	0-65535	0-65535	0-65535
DSP Resources	01-32	01-32	01-32
H.323 Alias Addresses	1-6	1-6	1-6

Flexible System Numbering Introduction



System Number Plan/Capacities			
System Type:	Aspire S	Aspire M/L	Aspire XL
Passwords			
User Password for setting Toll Restriction Override and Changing Class of Service using a service code	0000	0000	0000
Programming Passwords			
Level 1 (MF) PCPro/WebPro User Name:	374772 NEC-I	374772 NEC-I	374772 NEC-I
Level 2 (IN) PCPro/WebPro User Name:	12345678 ASPIRE	12345678 ASPIRE	12345678 ASPIRE
Level 3 (SA) PCPro/WebPro User Name:	0000 ADMIN1	0000 ADMIN1	0000 ADMIN1
Level 4 (SB) PCPro/WebPro User Name:	9999 ADMIN2	9999 ADMIN2	9999 ADMIN2
Programming Password Users	8	8	8
Note:			
Extension numbers can be three or four digits long. See Flexible System Numbering.			

4

An Example

In this example, a two-story motel requires room telephone extension numbers matched to the room numbers.

The motel first floor rooms are numbered 101-150; the second floor rooms are numbered 201-250. The following steps briefly outline the programming required to match the extension numbers to the room numbers.

For more details, refer to the flow chart at right and the specific programs beginning on page 4-9.

1. In Program 11-01 : System Numbering:

- Change the function of the 100 series numbers from Service Code (type 1) to Extension Access (type 2).
- Also change the function of the the 200 series numbers from Service Code (type 1) to Extension Access (type 2).
- Change the function of the 300 series numbers from Extension Access (2) to Service Code (type 1).

2. In Program 11-02 : Extension Numbering:

- Assign extension ports 1-50 (installed in rooms 101-150) to extension numbers 101-150.
- Assign extension ports 51-100 (installed in rooms 201-250) to extension numbers 201-250.

3. In Programs 11-10 - 11-15 : Service Code Setup:

- Change all 100 series Service Codes to 300 series codes. For example, in Program 11-10-12, change the Service Code number from 118 to 318.

Setting Up Flexible System Numbering

To set up Flexible System Numbering:

Use the flow chart on the following page to guide you through the basics of changing your numbering plan. Refer to the individual programs beginning on page 4-13.

Programming Flow Chart

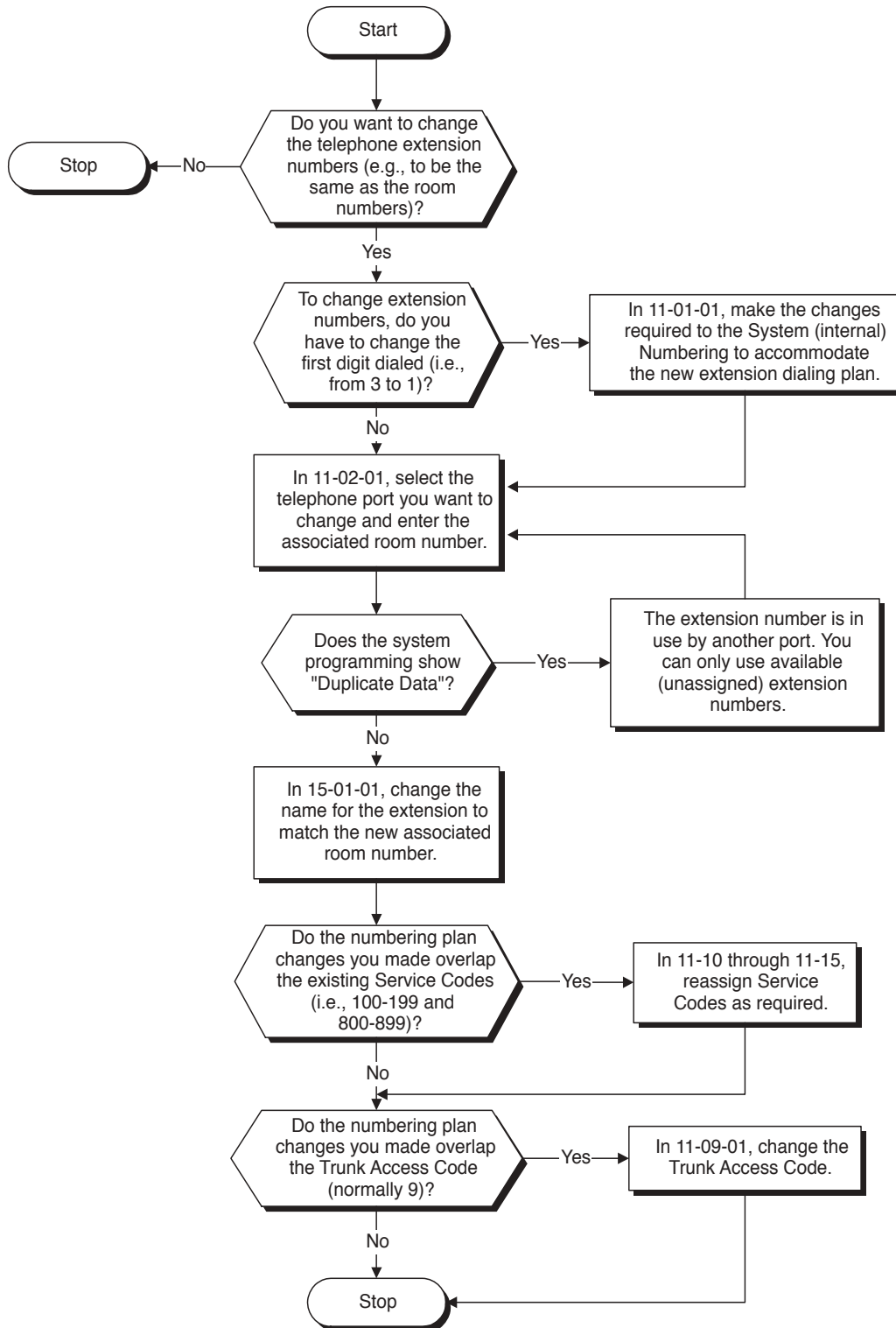

Programming

11-01 : System Numbering

Level:	Aspire S	Aspire M/L/XL
IN	• Available.	• Available.

Description

Use **Program 11-01 : System Numbering** to set the system’s internal (Intercom) numbering plan. The numbering plan assigns the first and second digits dialed and affects the digits an extension user must dial to access other extensions and features, such as service codes and trunk codes. If the default numbering plan does not meet the site requirements (i.e., you cannot make room numbers be the same as telephone extension numbers), use this program to tailor the system numbering to the site.

CAUTION

Improperly programming this option can adversely affect system operation. Make sure you thoroughly understand the default numbering plan before proceeding. If you must change the standard numbering, use the chart for **System Numbering** (page 4-16) to keep careful and accurate records of your changes.

Before changing your numbering plan, use the PC Program or Program 90-03 to make a backup copy of your system’s data.

Changing the numbering plan consists of three steps:

1. Enter the digits you want to change.
2. Specify the length of the code you select to change.
3. Assign a function to the code selected.

Step 1: Enter the digit(s) you want to change

You can make either single or two digit entries. In the Dialed Number column in the **System Numbering** (page 4-16) table, the nX rows (e.g., 1X) are for single digit codes. The remaining rows (e.g., 11, 12, etc.) are for two digit codes.

- Entering a single digit affects all the Dialed Number entries beginning with that digit. For example, entering 6 affects all number plan entries beginning with 6. The entries you make in step 2 and step 3 below affect the entire range of numbers beginning with 6. (For example, if you enter 3 in step 2 the entries affected would be 600-699. If you enter 4 in step 2 below, the entries affected would be 6000-6999.)
- Entering two digits lets you define codes based on the first two digits a user dials. For example, entering 60 allows you to define the function of all codes beginning with 60. In the default program, only * and # use two-digit codes. All the other codes are single digit. If you enter a two digit code between 0 and 9, be sure to make separate entries for all the other two digit codes within the range as well. This is because in the default program all the two digit codes between 0 and 9 are undefined.

Flexible System Numbering

11-01 : System Numbering

Step 2: Specify the length of the code you want to change

After you specify a single or two digit code, you must tell the system how many digits comprise the code. This is the *Number of Digits Required* column in the **System Numbering** (page 4-16) table. In the default program, all codes from 100-999 are three digits long. Codes beginning with 0 are one digit long. Codes beginning with * are 3 digits long and codes beginning with # are 4 digits long.

- If you are programming two digit codes in the PC Program, make sure the nX entry for *Number of Digits Required* is the maximum allowed by any of the two digit codes in the range. This is why the default *Number of Digits Required* entry for #X is four digits long. Even though #1-#9, #0 and ## entries require only two digits, #* requires four. If you inadvertently change #* to 2, you will no longer be able to enter #** to enter the programming mode.

Step 3: Assign a function to the code selected

After entering a code and specifying its length, you must assign its function. This is the Dial Type column in the **System Numbering** (page 4-16) table. The choices are:

Dial Types	Dial Type Description	Related Program
0	- Not Used -	
1	Service Code	11-10 : Service Code Setup (for System Administrator) 11-11 : Service Code Setup (for Registration) 11-12 : Service Code Setup (for Service Access) 11-13 : Service Code Setup (for ACD) 11-14 : Service Code Setup (for HOTEL) 11-15 : Service Code Setup (Special access)
2	Extension Number	11-02 : Extension Numbers 11-04 : Virtual Extension Numbers 11-06 : 2PGDAD (ACI) Extension Numbers 11-07 : Department Calling Group Numbers 11-08 : 2PGDAD (ACI) Group Pilot Numbers
3	Trunk Access Code	11-09 : Trunk Access Code
4	Special Trunk Access	11-09 : Trunk Access Code
5	Operator Access	20-17 : Operator's Extension
6	ARS/F-Route Access	44-xx
8	Networking	10-03 : PCB Setup 10-12 : NTCPU Network Setup 10-20 : LAN Setup for External Equipment 10-27 : IP System IP

- Changing the *Dial Type* for a range of codes can have a dramatic affect on how your system operates. Assume, for example, the site is a hotel that has room numbers from 100-399. In order to make extension numbers correspond to room numbers, you should:
 - Change the Dial Type for the digit 1 from 1 (Service Code) to 2 (extension number).
 - Change the Dial Type for the digit 7 from 2 (extension number) to 1 (Service Code).
 - In Program 11-02, reassign extension numbers on each floor from 100 to 399.
 - In Programs 11-10 through 11-15, reassign the Service Codes from the 100 series (e.g., 116) to the 700 series (e.g., 716). (Other applications might also require you to change entries in Program 11-10 through 11-15.)
 - Check Program 11-16 to be sure that the Single Digit Service Code 04 (digit 7) does not affect any post dial Service Codes codes in Programs 11-10 through 11-15. (Unless you changed codes from their default assignments, this would not be the case.)
 - In Program 45-01-03, enter “0” to disable Voice Mail Call Screening. If you left screening enabled, Voice Mail ports could call the wrong extensions. For example, a Voice Mail port trying to call screen extension 130 would outdial 1130. This would call extension 113 instead.

Extension numbers now will correspond to room numbers, and all the Service Codes in the 100 series will be in the 700 series.

Default

See the following tables.

Flexible System Numbering

11-01 : System Numbering

4

System Numbering					
Dial Types: 1=Service Code, 2=Extension Number, 3=Trunk Access, 4=Special Trunk Access, 5=Operator Access, 6=Flexible Routing, 8=Networking, 0=Not Used					
Dialed Number	Number of Digits Required		Dial Type		Network System ID [if type 8] - 0-50
	Default	New	Default	New	
1X	3		1		
11	0		0		
12	0		0		
13	0		0		
14	0		0		
15	0		0		
16	0		0		
17	0		0		
18	0		0		
19	0		0		
10	0		0		
1*	0		0		
1#	0		0		
2X					
2X	3		2		
21	0		0		
22	0		0		
23	0		0		
24	0		0		
25	0		0		
26	0		0		
27	0		0		
28	0		0		
29	0		0		
20	0		0		
2*	0		0		
2#	0		0		

System Numbering					
Dial Types: 1=Service Code, 2=Extension Number, 3=Trunk Access, 4=Special Trunk Access, 5=Operator Access, 6=Flexible Routing, 8=Networking, 0=Not Used					
Dialed Number	Number of Digits Required		Dial Type		Network System ID [if type 8] - 0-50
	Default	New	Default	New	
3X	3		2		
31	0		0		
32	0		0		
33	0		0		
34	0		0		
35	0		0		
36	0		0		
37	0		0		
38	0		0		
39	0		0		
30	0		0		
3*	0		0		
3#	0		0		
4X	3		2		
41	0		0		
42	0		0		
43	0		0		
44	0		0		
45	0		0		
46	0		0		
47	0		0		
48	0		0		
49	0		0		
40	0		0		
4*	0		0		
4#	0		0		

Flexible System Numbering

11-01 : System Numbering

4

System Numbering					
Dial Types: 1=Service Code, 2=Extension Number, 3=Trunk Access, 4=Special Trunk Access, 5=Operator Access, 6=Flexible Routing, 8=Networking, 0=Not Used					
Dialed Number	Number of Digits Required		Dial Type		Network System ID [if type 8] - 0-50
	Default	New	Default	New	
5X	3		2		
51	0		0		
52	0		0		
53	0		0		
54	0		0		
55	0		0		
56	0		0		
57	0		0		
58	0		0		
59	0		0		
50	0		0		
5*	0		0		
5#	0		0		
6X	3		2		
61	0		0		
62	0		0		
63	0		0		
64	0		0		
65	0		0		
66	0		0		
67	0		0		
68	0		0		
69	0		0		
60	0		0		
6*	0		0		
6#	0		0		

System Numbering					
Dial Types: 1=Service Code, 2=Extension Number, 3=Trunk Access, 4=Special Trunk Access, 5=Operator Access, 6=Flexible Routing, 8=Networking, 0=Not Used					
Dialed Number	Number of Digits Required		Dial Type		Network System ID [if type 8] - 0-50
	Default	New	Default	New	
7X	3		2		
71	0		0		
72	0		0		
73	0		0		
74	0		0		
75	0		0		
76	0		0		
77	0		0		
78	0		0		
79	0		0		
70	0		0		
7*	0		0		
7#	0		0		
8X	3		1		
81	0		0		
82	0		0		
83	0		0		
84	0		0		
85	0		0		
86	0		0		
87	0		0		
88	0		0		
89	0		0		
80	0		0		
8*	0		0		
8#	0		0		

Flexible System Numbering

11-01 : System Numbering

4

System Numbering					
Dial Types: 1=Service Code, 2=Extension Number, 3=Trunk Access, 4=Special Trunk Access, 5=Operator Access, 6=Flexible Routing, 8=Networking, 0=Not Used					
Dialed Number	Number of Digits Required		Dial Type		Network System ID [if type 8] - 0-50
	Default	New	Default	New	
9X	1		3		
91	0		0		
92	0		0		
93	0		0		
94	0		0		
95	0		0		
96	0		0		
97	0		0		
98	0		0		
99	0		0		
90	0		0		
9*	0		0		
9#	0		0		
Separator					
0X	1		5		
01	0		0		
02	0		0		
03	0		0		
04	0		0		
05	0		0		
06	0		0		
07	0		0		
08	0		0		
09	0		0		
00	0		0		
0*	0		0		
0#	0		0		

System Numbering					
Dial Types: 1=Service Code, 2=Extension Number, 3=Trunk Access, 4=Special Trunk Access, 5=Operator Access, 6=Flexible Routing, 8=Networking, 0=Not Used					
Dialed Number	Number of Digits Required		Dial Type		Network System ID [if type 8] - 0-50
	Default	New	Default	New	
*X	2		1		
*1	0		0		
*2	0		0		
*3	0		0		
*4	0		0		
*5	0		0		
*6	0		0		
*7	0		0		
*8	0		0		
*9	0		0		
*0	0		0		
**	0		0		
*#	0		0		
#X	0		0		
#1	2		1		
#2	2		1		
#3	2		1		
#4	2		1		
#5	2		1		
#6	2		1		
#7	2		1		
#8	2		1		
#9	2		1		
#0	2		1		
#*	4		1		
##	2		1		

Conditions

None

Feature Cross Reference

- Flexible System Numbering

Telephone Programming Instructions

To enter data for Program 11-01 (System Numbering):

1. Enter the programming mode.
2. 11 01

```
11-01-01 Dial 1
1x      Digit 3
back  ↑    ↓    select
```

3. Enter the number of the item you want to program.

```
11-01-nn
nnnnn
←          →
```

4. Select the dial number to be programmed by pressing the FLASH or the VOLUME ▲ or VOLUME ▼ keys.
5. Enter data for the item you selected + HOLD.
6. Enter data for the next item in the program.
OR
Press MSG once to enter a new item number.
OR
Press MSG until you've exited that series's programming section.

11-02 : Extension Numbering

Level:	Aspire S	Aspire M/L/XL
IN	• Available.	• Available.

Description

Use **Program 11-02 : Extension Numbering** to set the extension number. This allows you have room number match the room telephone extension number. The extension number can be up to eight digits long. The first/second digit(s) of the number should be assigned in Program 11-01. This lets an employee move to a new location (port) and retain the same extension number.

Input Data

Extension Port Number	001-512
-----------------------	---------

Item No.	Extension Number	Description
01	Dial (Up to 8 digits)	<ul style="list-style-type: none"> • Set up extension numbers for Key Telephones, Single Line Telephones (Including SLT and APR adapters), and IP Telephones. • Extension number assignments cannot be duplicated.



Default

Extension Port Number	Extension Number
1	301
2	302
3	303
:	:
199	499
200	5000
:	:
512	5312

Conditions

None

Feature Cross Reference

- Department Calling
- Flexible System Numbering
- Intercom

Telephone Programming Instructions

To enter data for Program 11-02 (Extension Numbering):

1. Enter the programming mode.
2. 11 02

```
11-02-01 Extn Port1
Extension_No.
back ↑ ↓ select
```

3. Enter the number of the item you want to program.

```
11-02-nn Extn Portnnn
nnnnn
← →
```

4. Select the extension port number to be programmed by pressing the FLASH or the VOLUME ▲ or VOLUME ▼ keys.
5. Enter data for the item you selected + HOLD.
6. Enter data for the next item in the program.
OR
Press MSG once to enter a new item number.
OR
Press MSG until you've exited that series's programming section.

11-09 : Trunk Access Code

Level:	Aspire S	Aspire M/L/XL
IN	• Available.	• Available.

Description

Use **Program 11-09 : Trunk Access Code** to assign the trunk access code (normally 9). The trunk access code can be set from 1 to 8 digits which is defined to type 3 and 4 in Program 11-01. This is the code extension users dial to access Automatic Route Selection or Trunk Group Routing. The Individual Trunk Access Code is used when Trunk Group Routing is desired for an outgoing line. You should only have to change this option when matching room numbers to extension numbers if the facility has rooms beginning with the digit 9.

Caution

The digit 9 is defined in Program 11-01 as Dial Type 3 with the Number of Digits Required set to 1. If you change the trunk access code in Program 11-09, you must make the corresponding changes in Program 11-01.

Input Data

Item No.	Item	Input Data	Default	Description	Related Program
01	Trunk Access Code	Dial (Up to 4 digits)	9	Use this program to assign the trunk access code (normally 9). This is the code extension users dial to access Automatic Route Selection.	<ul style="list-style-type: none"> • 11-01 : System Numbering • 14-01 : Trunk Basic Data Setup • 14-05 : Trunk Group • 14-06 : Trunk Group Routing
02	Alternate Trunk Route Access Code	Dial (Up to 4 digits)	No setting	Use this program to define additional trunk access codes. When a user dials the Alternate Trunk Route Access Code, the system routes their call to the Alternate Trunk Route.	<ul style="list-style-type: none"> • 11-01 : System Numbering • 14-01 : Trunk Basic Data Setup • 14-05 : Trunk Group • 14-06 : Trunk Group Routing • 21-02 : Trunk Group Routing for Extensions • 21-15 : Alternate Trunk Group Routing for Extensions

Conditions

None

Feature Cross Reference

- Automatic Route Selection
- Central Office Calls, Placing
- Trunk Group Routing

Telephone Programming Instructions

To enter data for Program 11-09 (Trunk Access Code):

1. Enter the programming mode.
2. 11 09

```
11-09-01
Trunk_Access_Code0
back  ↑   ↓  select
```

3. Enter the number of the item you want to program.

```
11-09-nn
nnnnn
←           →
```

4. Enter data for the item you selected + HOLD.
5. Enter data for the next item in the program.
OR
Press MSG once to enter a new item number.
OR
Press MSG until you've exited that series's programming section.

11-10 : Service Code Setup (for System Administrator)

Level: IN	Aspire S	Aspire M/L/XL
	<ul style="list-style-type: none"> Available. Aspire Wireless service code items 30 and 31 are not available. 	<ul style="list-style-type: none"> Available. Aspire Wireless service code items 30 and 31 are available.

Description

Use **Program 11-10 : Service Code Setup (for System Administrator)** to customize the Service Codes for the System Administrator. You can customize additional Service Codes in Programs 11-11 through 11-16. You will have to customize your Service Codes if the extension numbers you selected in Program 11-02 overlap the default Service Codes (100-199 and 800-899).

The following chart shows:

- The number of each code (01-27)
- The function of the Service Code.
- What type of telephones can use the Service Code
- The code's default entry. For example, dialing *3 (item 26) allows users to force a trunk line to disconnect.
- Programs that may be affected with the changing the code.

If you change a Service Code, be sure to record your entry in the "New" column.

Input Data

Item No.	Item	Terminals	Default	New	Related Program
01	Day / Night Mode Switching	KTS, SLT	818		12-xx 20-07-01
02	Changing the Music on Hold Tone	KTS	881		10-04
03	Setting the System Time	KTS	828		
04	Storing Common Abbreviated Dialing Numbers	KTS	853		
05	Storing Group Abbreviated Dialing Numbers	KTS	854		
06	Setting the Automatic Forwarding for Each Trunk Line	KTS	833		24-04-01
07	Canceling the Automatic Forwarding for Each Trunk Line	KTS	834		24-04-01
08	Setting the Destination for Automatic Trunk Forwarding	KTS	835		24-04-01
09	Not Used		No Setting		

Flexible System Numbering

11-10 : Service Code Setup (System Administrator)



Item No.	Item	Terminals	Default	New	Related Program
10	Not Used	-	-	-	-
11	Entry of Credit for Toll Restriction - Not Used		No Setting		
12	Night Mode Switching for Other Group	KTS	118		12-xx 20-07-01
13	Not Used	-	-	-	-
14	Not Used	-	-	-	-
15	Not Used	-	-	-	-
16	Leaving Message Waiting	KTS	126		11-11-09
17	Dial Block by Supervisor	KTS	101		90-19
18	Off-Premise Call Forward by Door Box	KTS	822		13-05
19	Not Used	-	-	-	-
20	VRS - Record/Erase Message	KTS	116		20-07-13
21	VRS - General Message Playback	KTS	111		20-07-14
22	VRS - Record or Erase General Message	KTS	112		20-07-15
23	SMDR - Extension Accumulated Printout Code	KTS	121		20-07-18
24	SMDR - Group Accumulated Printout Code	KTS	122		20-07-19
25	Account Code Accumulated Printout Code	KTS	123		20-07-20
26	Forced Trunk Disconnect	KTS, SLT	*3		20-07-11
27	Trunk Port Disable for Outgoing Calls	KTS	145		20-07-12
28	Not Used	-	-	-	-
29	Not Used	-	-	-	-
30	Register Aspire Wireless Handset Define the service code to be used to register an Aspire Wireless handset.	KTS	-		20-07-21
31	Unregister Aspire Wireless Handset Define the service code to be used to unregister an Aspire Wireless handset.	KTS	-		20-07-21
32	Set Private Call Refuse Define the service code to be used to set the "Private" call refusal for the trunks which are programmed in Program 14-01-27 to 1.	KTS, SLT	No Setting		14-01-27
33	Enter Caller ID Refuse For keysets only, define the service code to be used to add or delete the Caller ID numbers to be refused.	KTS, SLT	No Setting		14-01-27

4

Item No.	Item	Terminals	Default	New	Related Program
34	Set Caller ID Refuse Define the service code to be used to enable/disable the Caller ID call refusal for the trunks which are programmed in Program 14-01-27 to 1.		No Setting		14-01-27
35	DID Mode Switching Assign the service code to be used to manually change the time pattern for a DID number.	KST, SLT	No Setting		

Conditions

None

Feature Cross Reference

Refer to chart above.

Telephone Programming Instructions

To enter data for Program 11-10 (Service Code Setup (for System Administrator)):

1. Enter the programming mode.
2. 11 10

```
11-10-01
NT-Mode_Switch *01
back ↑ ↓ select
```

3. Enter the number of the item you want to program.

```
11-10-nn
nnnn
← →
```

4. Enter data for the item you selected + HOLD.
5. Enter data for the next item in the program.
OR
Press MSG once to enter a new item number.
OR
Press MSG until you've exited that series's programming section.

Flexible System Numbering

11-11 : Service Code Setup (Setup/Entry Operation) *Aspire*

11-11 : Service Code Setup (for Setup/Entry Operation)

Level:	Aspire S	Aspire M/L/XL
IN	• Available.	• Available.

Description

Use **Program 11-11 : Service Code Setup (for Setup/Entry Operation)** to customize the Service Codes which are used for registration and setup. You can customize additional Service Codes in Programs 11-10, and 11-12 through 11-16. You will have to customize your Service Codes if the extension numbers you selected in Program 11-02 overlap the default Service Codes (100-199 and 800-899).

The following chart shows:

- The number of each code (01-38)
- The function of the Service Code.
- What type of telephones can use the Service Code
- The code's default entry. For example, dialing 825 (item 18) allows users to turn on or turn off Background Music.
- Programs that may be affected with the changing the code.

If you change a Service Code, be sure to record your entry in the “New” column.

Input Data

Item No.	Item	Terminals	Default	New	Related Program
01	Call Forward - Immediate	KTS, SLT	No Setting		
02	Call Forward - Busy	KTS, SLT	No Setting		
03	Call Forward - No Answer	KTS, SLT	No Setting		
04	Call Forward - Busy/No Answer	KTS, SLT	No Setting		
05	Call Forward - Both Ring	KTS, SLT	No Setting		
06	Call Forwarding - Select Option	KTS, SLT	*2		
07	Call Forwarding - Follow-Me	KTS, SLT	No Setting		
08	Do Not Disturb	KTS, SLT	847		
09	Answer Message Waiting	KTS, SLT	*0		11-10-16
10	Cancel All Messages Waiting	KTS, SLT	873		
11	Cancel Message Waiting	KTS, SLT	871		
12	Alarm Clock	KTS, SLT	827		20-01-06

Flexible System Numbering

Aspire 11-11 : Service Code Setup (Setup/Entry Operation)

4

Item No.	Item	Terminals	Default	New	Related Program
13	Display Language Selection for Keypad	KTS	178		15-02
14	Text Message Setting	KTS	No Setting		
15	Enable Handsfree Incoming Intercom Calls	KTS	821		20-09-05 20-02-12
16	Force Ringing of Incoming Intercom Calls	KTS	823		20-09-05 20-02-12
17	Programmable Function Key Programming (Dialing 851 Service Code)	KTS	851		15-07 11-11-38
18	BGM On/Off	KTS	825		
19	Key Touch Tone On/Off	KTS	824		
20	Change Incoming CO and ICM Ring Tones	KTS	820		15-02
21	Check Incoming Ring Tones	KTS	811		
22	Extension Name Programming	KTS	800		15-01
23	Second Call for DID/DISA/DIL	KTS	179		
24	Change Extension Class of Service Allows an extension user to change the COS of another extension. Must be allowed in Program 20-13-28.	KTS	177		20-13-28
25	Automatic Transfer Setup for Each Department Group	KTS, SLT	102		20-11-17 24-05
26	Automatic Transfer Cancellation for Each Department Group	KTS, SLT	103		
27	Destination of Automatic Transfer Each Department Group	KTS	104		20-11-17 24-05
28	Delayed Transfer for Every Department Group	KTS, SLT	105		20-11-17 24-05 24-02-08
29	Delayed Transfer Cancellation for Each Department Group	KTS, SLT	106		20-11-17
30	DND Setup for Each Department Group	KTS, SLT	107		
31	DND Cancellation for Each Department Group	KTS, SLT	108		
32	Not Used	-	-	-	-
33	Dial Block	KTS, SLT	100		
34	Temporary Toll Restriction Override	KTS, SLT	875		21-07
35	Pilot Group Withdrawing	KTS, SLT	150		

Flexible System Numbering

11-11 : Service Code Setup (Setup/Entry Operation) *Aspire*

Item No.	Item	Terminals	Default	New	Related Program
36	Toll Restriction Override	KTS, SLT	163		21-14
37	Adjusting Ring Volume	KTS	829		
38	Programmable Function Key Programming (Dialing 852 Service Code)	KTS	852		15-07 11-11-17
39	One Touch Dial Number Entry	KTS	855		
40	Off-Premise Call Forwarding	KTS, SLT	*4		
41	Tandem Ringing	KTS, SLT	No Setting		15-07 30-03
42	Aspire Wireless Transferring When Out of Range Customize the service code to be used when setting a Aspire Wireless phone to transfer calls when out of range.	Aspire Wireless	189		
43	Headset Mode Switching This option determines how long after the hookswitch is released the SLT will hear dial tone before the phone goes into headset mode.	SLT	188		
44	Automated Attendant (DSPDB) - Not Used in U.S. -	-	-	-	-
56	Telephone Book Lock Service Using the service code defined in this option, users can change the system Telephone Book lock status.	KTS	No Setting		

Conditions

None

Feature Cross Reference

Refer to chart above.

Aspire 11-11 : Service Code Setup (Setup/Entry Operation)

Telephone Programming Instructions

To enter data for Program 11-11 (Service Code Setup (for Setup/Entry Operation)):

1. Enter the programming mode.
2. 11 11

```
11-11-01
Call_Forward-Imm901
back ↑ ↓ select
```

3. Enter the number of the item you want to program.

```
11-11-nn
nnnnn
← →
```

4. Enter data for the item you selected + HOLD.
5. Enter data for the next item in the program.
OR
Press MSG once to enter a new item number.
OR
Press MSG until you've exited that series's programming section.

Flexible System Numbering

11-12 : Service Code Setup (for Service Access)

11-12 : Service Code Setup (for Service Access)

Level:	Aspire S	Aspire M/L/XL
IN	• Available.	• Available.

Description

Use **Program 11-12 : Service Code Setup (for Service Access)** to customize the Service Codes which are used for service access. You can customize additional Service Codes in Programs 11-10, 11-11, and 11-13 through 11-16. You will have to customize your Service Codes if the extension numbers you selected in Program 11-02 overlap the default Service Codes (100-199 and 800-899).

The following chart shows:

- The number of each code (01-48)
- The function of the Service Code.
- What type of telephones can use the Service Code
- The code’s default entry. For example, dialing 805 (code 05) will cancel a previously set Camp-On.
- Programs that may be affected with the changing the code.

If you change a Service Code, be sure to record your entry in the “New” column.

For “8xx” service codes used after dialing an extension (post-dialing), Program 11-16-09 (Single Digit Voice Mail code) must be deleted or changed from the default entry of “8” for the service codes to work.

Input Data

Item No.	Item	Terminals	Default	New	Related Program
01	Call Forwarding / Do Not Disturb Override Activating Call Forwarding/Do Not Disturb Override. This code is only available if you disable the voice mail Single Digit dialing code in Program 11-16-09.	KTS, SLT	807		11-16-09
02	Conference	KTS, SLT	#1		
03	Override (Off-Hook Signaling)	KTS, SLT	809		
04	Set Camp-On	KTS, SLT	850		
05	Cancel Camp-On	KTS, SLT	870		
06	Switching of Voice Call and Signal Call Used to toggle an ICM call between Handsfree Answerback and Forced Intercom Ringing for outgoing Intercom calls.	KTS, SLT	812		
07	Step Call	KTS, SLT	808		

Item No.	Item	Terminals	Default	New	Related Program
08	Barge-In	KTS, SLT	810		
09	Change to STG All Ring	KTS, SLT	No Setting		16-02
10	Common/Extension Abbreviated Dialing	KTS, SLT	#2		
11	Group Abbreviated Dialing	KTS, SLT	#4		
12	Last Number Dial	KTS, SLT	#5		
13	Saved Number Dial	KTS, SLT	815		
14	Trunk Group Access	KTS, SLT	804		
15	Specified Trunk Access	KTS, SLT	#9		
16	Trunk Access Via Networking	KTS	No Setting		
17	Clear Last Number Dialing Data	KTS, SLT	876		
18	Clear Saved Number Dialing Data	KTS, SLT	885		
19	Internal Group Paging	KTS, SLT	801		31-01-01
20	External Paging	KTS, SLT	803		
21	Meet Me Answer to Specified Internal Paging Group	KTS, SLT	864		
22	Meet Me Answer to External Paging	KTS, SLT	865		
23	Meet Me Answer in Same Paging Group	KTS, SLT	863		
24	Combined Paging	KTS, SLT	*1		31-07
25	Direct Call Pickup - Own Group	KTS, SLT	856		
26	Call Pickup for Specified Group	KTS, SLT	868		
27	Call Pickup	KTS, SLT	*#		
28	Call Pickup for Another Group	KTS, SLT	869		
29	Direct Extension Call Pickup	KTS, SLT	**		
30	Specified Trunk Answer	KTS, SLT	172		
31	Park	KTS, SLT	#6		24-03
32	Answer for Park	KTS, SLT	*6		24-03
33	Group Hold	KTS, SLT	832		
34	Answer for Group Hold	KTS, SLT	862		
35	Personal (Extension) Park	KTS, SLT	857		
36	Door Box Access	KTS, SLT	802		

Flexible System Numbering

11-12 : Service Code Setup (for Service Access)

4

Item No.	Item	Terminals	Default	New	Related Program
37	Common Canceling Service Code	KTS, SLT	120		
38	Not Used	-	883	-	-
39	VRS Access - Not Used in U.S. -	KTS, SLT	884		
40	Personal Abbreviated Dialing	KTS, SLT	#7		
41	Voice Over	KTS	890		11-16-08
42	Flash on Trunk lines	SLT	#3		
43	Universal Answer	SLT	#0		14-05 14-06
44	Callback Test for SLT	SLT	899		
45	Enabled On Hook When Holding (SLT)	SLT	849		15-03-07
46	Answer On Hook When Holding (SLT)	SLT	859		15-03-08
47	Call Waiting Answer / Split Answer Splitting (switching) between calls	KST/SLT	894		11-12-03
48	Account Code	SLT	##		
49	Not Used	-	-	-	-
50	General Purpose Relay	KST	880		
51	Call Own Mailbox		*8		
52	Live Monitoring (VRS)		No Setting		
53	Live Recording at SLT	SLT	154		
54	VRS Routing for ANI/DNIS Use when setting up ANI/DNIS Routing to the VRS Automated Attendant. Using the Transfer feature, this also allows a call to be transferred to the VRS.		882		
56	E911 Alarm Shut Off Enter the Service Code that an extension user can dial to shut off the E911 Alarm Ring.		886	-	20-08-16 21-01-13
57	Unsupervised Conference/Tandem Trunking	KST/SLT	#8		
58	Transfer Into Conference Assign the Service Code users dial to Transfer a call into a Conference call.	KST/SLT	124		20-13-10 20-13-15 20-13-16

Conditions

For “8xx” service codes used after dialing an extension (post-dialing), Program 11-16-09 (Single Digit Voice Mail code) must be deleted or changed from the default entry of “8” for the service codes to work.

Feature Cross Reference

Refer to chart above.

Telephone Programming Instructions

To enter data for Program 11-12 (Service Code Setup (for Service Access)):

1. Enter the programming mode.
2. 11 12



11-12-01
Bypass_Call 801
back ↑ ↓ select

3. Enter the number of the item you want to program.



11-12-nn
nnnnn
← →

4. Enter data for the item you selected + HOLD.
5. Enter data for the next item in the program.
OR
Press MSG once to enter a new item number.
OR
Press MSG until you've exited that series's programming section.

Flexible System Numbering

11-13 : Service Code Setup (for ACD)

11-13 : Service Code Setup (for ACD)

Level:	Aspire S	Aspire M/L/XL
IN	• Not Available.	• Available.

Description

Use **Program 11-13 : Service Code Setup (for ACD)** to customize the Service Codes which are used with the Automatic Call Distribution (ACD) feature. You can customize additional Service Codes in Programs 11-10 through 11-12 and 11-14 through 11-16. You will have to customize your Service Codes if the extension numbers you selected in Program 11-02 overlap the default Service Codes (100-199 and 800-899).

The following chart shows:

- The number of each code (01-09)
- The function of the Service Code.
- What type of telephones can use the Service Code
- The code's default entry.

If you change a Service Code, be sure to record your entry in the “New” column.

Input Data

Item No.	Item	Terminals	Default	New
01	ACD Log In / Log Out (for KTS)	KTS, SLT	*5	
02	ACD Log Out (for SLT)	SLT	155	
03	Set ACD Wrap-Up Time (for SLT)	SLT	156	
04	Cancel ACD Wrap-Up Time (for SLT)	SLT	157	
05	Set ACD Off Duty (for SLT)	SLT	158	
06	Cancel ACD Off Duty (for SLT)	SLT	159	
07	ACD Conversation Recording (for SLT)	SLT	160	
08	ACD AIC Login Allows an AIC Agent to log into a group.	KTS	No setting	
09	ACD AIC Logout Allows an AIC Agent to log out of a group.	KTS	No setting	
10	ACD Agent Login by Supervisor Allows an ACD Supervisor to log into a group.	KTS	167	
11	ACD Agent Logout by Supervisor Allows an ACD Supervisor to log out of a group.	KTS	168	

12	Change Agent ACD Group by Supervisor When using service code 169 to change an agent’s ACD group, the supervisor must enter a 2-digit number for the group. For example, to change to ACD group 4, the entry would be ‘169 04’.	KTS	169	
13	ACD Agent Changing Own ACD Group Using this service code, an ACD Agent can reassign themselves to another ACD Group.	KTS	170	

Conditions

None

Feature Cross Reference

- Automatic Call Distribution (ACD)

Telephone Programming Instructions

To enter data for Program 11-13 (Service Code Setup (for ACD)):

1. Enter the programming mode.
2. 11 13

11-13-01
KT_ACD_LogIn/Out
back ↑ ↓ select
3. Enter the number of the item you want to program.

11-13-nn
nnnnn
← →
4. Enter data for the item you selected + HOLD.
5. Enter data for the next item in the program.
 OR
 Press MSG once to enter a new item number.
 OR
 Press MSG until you’ve exited that series’s programming section.

Flexible System Numbering

11-14 : Service Code Setup (for Hotel)

11-14 : Service Code Setup (for Hotel)

Level:	Aspire S	Aspire M/L/XL
IN	• Available.	• Available.

Description

Use **Program 11-14 : Service Code Setup (for Hotel)** to customize the Service Codes which are used with the Hotel/Motel feature. You can customize additional Service Codes in Programs 11-10 through 11-13, 11-15 and 11-16. The Service Codes can only be used at telephones registered as hotel terminals in Program 42-02. You will have to customize your Service Codes if the extension numbers you selected in Program 11-02 overlap the default Service Codes (100-199 and 800-899).

The following chart shows:

- The number of each code (01-17)
- The function of the Service Code.
- What type of telephones can use the Service Code
- The code's default entry.

If you change a Service Code, be sure to record your entry in the “New” column.

Input Data

Item No.	Item	Terminals	Default
01	Set DND for Own Extension	KTS, SLT	127
02	Cancel DND for Own Extension	KTS, SLT	128
03	Set DND for Other Extension	KTS, SLT	129
04	Cancel DND for Other Extension	KTS, SLT	130
05	Set Wake Up Call for Own Extension	KTS, SLT	131
06	Cancel Wake Up Call for Own Extension	KTS, SLT	132
07	Set Wake Up Call for Other Extension	KTS, SLT	133
08	Cancel Wake Up Call for Other Extension	KTS, SLT	134
09	Set Room-to-Room Call Restriction	KTS, SLT	135
10	Cancel Room-to-Room Call Restriction (Hotel)	KTS, SLT	136
11	Change Toll Restriction Class for Other Extension	KTS, SLT	137
12	Check-In	KTS, SLT	138
13	Check-Out	KTS, SLT	139

Item No.	Item	Terminals	Default
14	Room Status Change for Own Extension	KTS, SLT	140
15	Room Status Change for Other Extension	KTS, SLT	141
16	Room Status Output	KTS, SLT	142
17	Hotel Room Monitor	KTS, SLT	175
18	Hotel PMS Toll Restriction Set	KTS	166

Conditions

None

Feature Cross Reference

- Hotel/Motel

Telephone Programming Instructions

To enter data for Program 11-14 (Service Code Setup (for Hotel)):

1. Enter the programming mode.
2. 11 14

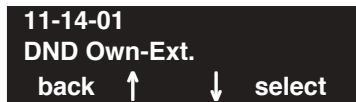

3. Enter the number of the item you want to program.



4. Enter data for the item you selected + HOLD.
5. Enter data for the next item in the program.
OR
Press MSG once to enter a new item number.
OR
Press MSG until you've exited that series's programming section.

Flexible System Numbering

11-15 : Service Code Setup, Administrative

11-15 : Service Code Setup, Administrative (for Special Access)

Level:	Aspire S	Aspire M/L/XL
IN	• Available.	• Available.

Description

Use **Program 11-15 : Service Code Setup, Administrative (for Special Access)** to customize the special access Service Codes which are used by the administrator in the Hotel/Motel feature. You can customize additional Service Codes in Programs 11-10 through 11-14 and 11-16. You will have to customize your Service Codes if the extension numbers you selected in Program 11-02 overlap the default Service Codes (100-199 and 800-899).

The following chart shows:

- The number of each code (01-07)
- The function of the Service Code.
- What type of telephones can use the Service Code
- The code's default entry.
- Programs that may be affected with the changing the code.

If you change a Service Code, be sure to record your entry in the “New” column.

Input Data

Item No.	Item	Terminals	Default	New	Related Program
01	Remote Maintenance Set the service code used in the dial-up number when using the serial or USB port for PCPro or WebPro		830		
02	ACD Access in Dial-In Conversion Table		860		22-04 22-11
03	Backup Data Save This option will save the user's soft key settings (extension's programmed Call Forwards, DND, etc.). It is recommended to use this feature before upgrading the system software.	KTS	##9		
04	Not Used				
05	System Programming Mode, Log-On	KTS	##*		11-01
06	Wake on LAN to APSU Unit	KTS	No Setting		10-22
07	Recording Destination in Dial-In Conversion Table		No Setting		
08	Network Message Lamp Control		866		

09	Transfer to Trunk Ring Group Code Allows a call to be transferred to a trunk ring group or External Paging zones.	KTS, SLT	No Setting		22-05-01 25-06-02 31-05-01
12	Extension Data Swap Define the service code (up to 8 digits) to be used with the Extension Data Swap feature.	KTS, SLT	No Setting		92-04-01
13	Function Setting via DISA Define the service code an outside caller dials when on a DISA line in order to access certain Aspire features.	KTS, SLT	8 Digits Max.	No Setting	

Conditions

None

Feature Cross Reference

- Hotel/Motel
- Maintenance

Telephone Programming Instructions



To enter data for Program 11-15 (Service Code Setup, Administrative (for Hotel)):

1. Enter the programming mode.
2. 11 15

```
11-15-01
Remote_Mainte #*01
back ↑ ↓ select
```

3. Enter the number of the item you want to program.

```
11-15-nn
nnnnnn
← →
```

4. Enter data for the item you selected + HOLD.
5. Enter data for the next item in the program.
OR
Press MSG once to enter a new item number.
OR
Press MSG until you've exited that series's programming section.

Flexible System Numbering

11-16 : Single Digit Service Code Setup

11-16 : Single Digit Service Code Setup

Level:	Aspire S	Aspire M/L/XL
IN	• Available.	• Available.

Description

Use **Program 11-16 : Single Digit Service Code Setup** to customize the one-digit Service Codes used when a busy or ring back signal is heard. You can customize additional Service Codes in Programs 11-10 through 11-15. The following chart shows:

- The number of each code (01-10)
- The function of the Service Code.
- What type of telephones can use the Service Code
- The code's default entry. For example, dialing 1 (code 03) when calling an extension will switch the call from either a voice or signal call (depending on how it's currently defined).
- Programs that may be affected by changing these codes.

If you change a Service Code, be sure to record your entry in the "New" column.

Input Data

Item No.	Item	Default	New	Related Program
01	Step Call	#		
02	Barge In	No Setting		
03	Switching of Voice/Signal Call	1		
04	Intercom Off Hook Signaling	7		
05	Camp-On	2		
06	DND/Call Forward Override	No Setting		
07	Message Waiting	0		
08	Voice Over	6		
09	Access to Voice Mail	8		
10	STG All Ring Mode	No Setting		16-01-05
11	Personal Park	No Setting		

Conditions

None

Feature Cross Reference

Refer to chart above.

Telephone Programming Instructions

To enter data for Program 11-16 (Single Digit Service Code Setup):

1. Enter the programming mode.
2. 11 16



3. Enter the number of the item you want to program.



4. Enter data for the item you selected + HOLD.
5. Enter data for the next item in the program.
OR
Press MSG once to enter a new item number.
OR
Press MSG until you've exited that series's programming section.

Flexible System Numbering

15-01 : Basic Extension Data Setup

15-01 : Basic Extension Data Setup

Level:	Aspire S	Aspire M/L/XL
SA	• Available.	• Available.

Description

Use **Program 15-01 : Basic Extension Data Setup** to define the name for each extension.

Note: The item numbers indicated below are different when using PCPro/WebPro. Refer to the program within the PCPro/WebPro application to determine the correct item number.

Key for Entering Names	
Use this keypad digit . . .	When you want to . . .
1	Enter characters: 1 @ [¥] ^ _ ` { } → ← Á À Â Ã Ç É Ê ì ó
2	Enter characters A-C, a-c, 2.
3	Enter characters D-F, d-f, 3.
4	Enter characters G-I, g-i, 4.
5	Enter characters J-L, j-l, 5.
6	Enter characters M-O, m-o, 6.
7	Enter characters P-S, p-s, 7.
8	Enter characters T-V, t-v, 8.
9	Enter characters W-Z, w-z, 9.
0	Enter characters: 0 ! “ # \$ % & ’ () ô o ú ä ö ü α ε θ
*	Enter characters: * + , - . / : ; < = > ? π Σ σ Ω ∞ ϕ ε
#	# = Accepts an entry (only required if two letters on the same key are needed - ex: TOM). Pressing # again = Space. (In system programming mode, use the right arrow soft key instead to accept and/or add a space.)
CONF	Clear the character entry one character at a time.
CLEAR	Clear all the entries from the point of the flashing cursor and to the right.

When using i-Series telephones on the Aspire system, not all the same characters are available. Refer to the following chart for the i-Series characters:

With i-Series Phones: Key for Entering Names	
Use this keypad digit . . .	When you want to . . .
1	Enter characters: 1 @ [¥] ^ _ ` { } → ← å blank blank blank blank blank blank blank blank
2	Enter characters A-C, a-c, 2.
3	Enter characters D-F, d-f, 3.



With i-Series Phones: Key for Entering Names	
Use this keypad digit . . .	When you want to . . .
4	Enter characters G-I, g-i, 4.
5	Enter characters J-L, j-l, 5.
6	Enter characters M-O, m-o, 6.
7	Enter characters P-S, p-s, 7.
8	Enter characters T-V, t-v, 8.
9	Enter characters W-Z, w-z, 9.
0	Enter characters: 0 ! “ # \$ % & ’ () blank blank blank ä ö ü α ε θ
*	Enter characters: * + , - . / : ; < = > ? π Σ σ Ω ∞ ϕ £
#	# = Accepts an entry (only required if two letters on the same key are needed - ex: TOM). Pressing # again = Space.
CONF	Clear the character entry one character at a time.
CLEAR	Clear all the entries from the point of the flashing cursor and to the right.

Input Data

Extension Number	Max. 8 digits
------------------	---------------



Item No.	Item	Input Data	Default	Related Program
01	<p>Extension Name Set the extension/virtual extension name.</p> <p>When entering names for use the IntraMail’s Directory Dialing, do not use non-alpha characters. To separate a first name from a last name, enter a space as a delimiter. By default, there are no extension names entered. You can enter names in any of the following formats:</p> <ul style="list-style-type: none"> • First • Last • First (space) Last • Last (space) First 	Up to 12 Characters (A-Z, upper and lower case letters available)	301 = STA 301 302 = STA 302 499 = STA 499 5000 = STA 5000 5312 = STA 5312	

Conditions

None

Feature Cross Reference

Flexible Numbering

Flexible System Numbering

15-01 : Basic Extension Data Setup

Telephone Programming Instructions

To enter data for Program 15-01 (Basic Extension Data Setup):

1. Enter the programming mode.
2. 15 01

```
15-01-01 TEL
Ext.Name = EXT
back ↑ ↓ select
```

3. Enter the number of the item you want to program.

```
15-01-nn TELnnn
nnnnn
← →
```

4. Select the telephone number to be programmed by pressing the FLASH or the VOLUME ▲ or VOLUME ▼ keys.
5. Enter data for the item you selected + HOLD.
6. Enter data for the next item in the program.
OR
Press MSG once to enter a new item number.
OR
Press MSG until you've exited that series's programming section.

- For Your Notes -

NEC

NEC Unified Solutions, Inc.
4 Forest Parkway, Shelton, CT 06484
Tel: 800-365-1928 Fax: 203-926-5458
www.necunifiedsolutions.com

Other Important Telephone Numbers

Sales:	203-926-5450
Customer Service:	203-926-5444
Customer Service FAX:	203-926-5454
Technical Service:	203-925-8801
Discontinued Product Service:	900-990-2541
Technical Training:	203-926-5430
Emergency Technical Service (After Hours)	203-929-7920

(Excludes discontinued products)

NEC

NEC Unified Solutions, Inc.
4 Forest Parkway, Shelton, CT 06484
TEL: 203-926-5400 FAX: 203-929-0535
www.necunifiedsolutions.com

March 24, 2006
Printed in U.S.A.



0893208